



NEW

NUEVA CARTA DE ACABADOS: CONSULTAR
NEW CHART OF FINISHES: CONSULT



www.trivelgaltes.com

ÍNDICE - INDEX

1 PREVEN - SOPORTES MAMPARA / PREVEN - SCREEN SUPPORTS

C19L	SOPORTE MAMPARA SOBREMESA. Vidrio Laminado. 6 - 10 mm <i>DESKTOP SCREEN SUPPORT. Laminated glass. 6 - 10 mm</i>	9
C19LTMA	SOPORTE MAMPARA MÓVIL ANTIVUELCO. Vidrio laminado templado o templado. 6-10 mm <i>ANTI-ROLL MOVABLE SCREEN SUPPORT. Tempered or tempered laminated glass. 6-10 mm</i>	9
C19LMA	SOPORTE MAMPARA MÓVIL ANTIVUELCO. Vidrio laminado. 8 - 10 mm <i>ANTI-ROLL MOVABLE SCREEN SUPPORT. Laminated glass. 8 - 10 mm</i>	9
C19SP	SOPORTE PINZA MAMPARA. Para vidrio templado-laminado-otros materiales. 6-10 mm <i>SCREEN CLAMP SUPPORT. For tempered-laminated-other materials. 6-10 mm</i>	9
C19PSP	PATA SOPORTE PINZA MAMPARA <i>SCREEN CLAMP SUPPORT LEG</i>	9

2 BISAGRAS / HINGES

DECO	Bisagras con retención mecánica, alineable y tornillería oculta <i>Hinges with mechanical retention, alignable and hidden screws</i>	10
BAR	Bisagras con retención mecánica y alineable <i>Hinges with mechanical retention and alignable</i>	10
BB	Bisagras con retención mecánica <i>Hinges with mechanical retention</i>	11
PICCOLO	Bisagras con retención mecánica para vidrio de 6/8mm <i>Hinges with mechanical retention for 6/8mm glass</i>	11
BEND	Bisagra con retención mecánica para vidrio curvado V10mm <i>Hinge with mechanical retention for 10mm curved glass</i>	11
SQUARE	Bisagras con retención mecánica <i>Hinges with mechanical retention</i>	12
SQUARE V12	Bisagras con retención mecánica para vidrio de 12mm <i>Hinges with mechanical retention for 12mm glass</i>	12
N	Bisagras sin retención <i>Hinges without retention</i>	12
BG18	Bisagras sin retención para galce <i>Hinges without retention for rebate depth</i>	13
VESTA	Bisagras con retención mecánica <i>Hinges with mechanical retention</i>	13
VESTA V12	Bisagras con retención mecánica para vidrio de 12mm <i>Hinges with mechanical retention for 12mm glass</i>	13
HIDROBI AT	Bisagras hidráulicas alineables con tapas (GRC5-UNE EN 1670:2007/AC:2008) V8/10/12mm <i>Adjustable hydraulic hinges with covers (GRC5-UNE EN 1670:2007/AC:2008) V8/10/12mm</i>	14
HIDROBI	Bisagras hidráulicas <i>Hydraulic hinges</i>	15
HIDROBI L	Bisagras sin retención <i>Hinges without retention</i>	15
HIDROBI M	Bisagras con retención mecánica <i>Hinges with mechanical retention</i>	15
HIDROBI MARK III	Bisagras hidráulicas MARK III para exterior <i>MARK III hydraulic hinges for exterior doors</i>	16
HIDROBI L MARK III	Bisagras sin retención MARK III para exterior <i>MARK III hinges without retention for exterior doors</i>	16
HIDROBI M MARK III	Bisagras con retención mecánica MARK III para exterior <i>MARK III hinges with mechanical retention for exterior doors</i>	16
HIDROBI A-MARK III	Bisagras hidráulicas ALINEABLES MARK III para exterior <i>Bisagras hydraulicas ALINEABLES MARK III para exterior</i>	16
HIDROBI A-M-MARK III	Bisagras con retención mecánica ALINEABLES MARK III para exterior <i>MARK III ADJUSTABLE hinges with mechanical reten,on for exterior doors</i>	17

ÍNDICE - INDEX

3 PERNIOS HIDRÁULICOS / HYDRAULIC PATCH FITTINGS

G100E	Kit pernio hidráulico para puertas de exterior <i>Hydraulic patch fitting kit for exterior doors</i>	18
G100EA	Kit pernio hidráulico para puertas de exterior <i>Hydraulic patch fitting kit for exterior doors</i>	18
G100	Kit pernio hidráulico <i>Hydraulic patch fitting kit</i>	18
G100A	Kit pernio hidráulico <i>Hydraulic patch fitting kit</i>	18

4 CIERRAPUERTAS SUELO / FLOOR SPRINGS

ESPLUGUES	Cierrapuertas (3 velocidades) <i>Floor springs (3 speeds)</i>	19-20
G75	Cierrapuertas <i>Floor springs</i>	21

5 HERRAJES / FITTINGS

GT	Herrajes regulables <i>Adjustable patch fittings</i>	22-23
GT V12	Herrajes regulables para vidrio de 12mm <i>Adjustable patch fittings for 12mm glass</i>	24
MILLENNIUM	Herrajes <i>Patch fittings</i>	25-26
N	Herrajes <i>Patch fittings</i>	27-28
N V12	Herrajes para vidrio de 12mm <i>Patch fittings for 12mm glass</i>	29
T	Herrajes y accesorios <i>Patch fittings and accessories</i>	31-32
T V12	Herrajes y accesorios para vidrio de 12mm <i>Patch fittings and accessories for 12mm glass</i>	31
SERIE 9000 FLAT	Herrajes para grandes dimensiones <i>Patch fittings for big dimesions</i>	32-33
WOOD	Herrajes carpintería <i>Carpentry hardware</i>	33

6 PLINTOS / DOOR RAILS

ROBUST	Plintos <i>Door Rails</i>	34
---------------	-------------------------------------	----

7 ANTIPÁNICOS Y CRDA/CRDO ANTIPÁNICO / ANTI-PANIC & ANTI-PANIC LOCKS/STRIKE BOX

BRAVE	Antipánicos con barra de empuje <i>Anti-panic with pushing bar</i>	35
SAFE	Cerraduras antipánico <i>Anti-panic locks</i>	36
SAFE MODULAR	Cerraduras antipánico modulares <i>Modular anti-panic locks</i>	36
SAFE CRDO	Cerraderos antipánico <i>Anti-panic strike boxes</i>	37

ÍNDICE - INDEX

8 CERRADURAS COSMO / COSMO LOCKS		38
9 CERRADURAS CRONO / CRONO LOCKS		39
10 CERRADURAS MIR / MIR LOCKS		40
11 CERRADURAS-CERRADEROS BASTET / BASTET LOCKS-STRIKE BOXES		41
12 CIERRES-ELECTROMAGNETICOS / ELECTROMAGNETIC LOCKS		
MILETO	Cerraduras electromagnéticas <i>Electromagnetic locks</i>	41
MAGNET	Cerraduras magnéticas <i>Magnetic locks</i>	42
13 CERRADURAS MEIA / MEIA LOCKS		
MEIA	Cerraduras <i>Locks</i>	42-43
MEIA ON/OFF	Cerraduras con indicador de uso <i>Locks with usage indicator</i>	44
MEIA MODULAR	Cerraduras <i>Locks</i>	44
14 CERRADURAS ARES-TER / ARES-TER LOCKS		
ARES	Cerraduras petaca con muesca <i>Flask locks with slot</i>	45-46
TER	Cerraduras petaca sin muesca <i>Flask locks without slot</i>	46-47
ARES MODULAR	Cerraduras petaca con muesca <i>Flask locks with slot</i>	47
TER MODULAR	Cerraduras petaca sin muesca <i>Flask locks without slot</i>	47
15 CERRADURAS SCONTO / SCONTO LOCKS		
SCONTO	Cerraduras galce <i>Rebate depth locks</i>	48-49
SCONTO MODULAR	Cerraduras galce <i>Rebate depth locks</i>	50

ÍNDICE - INDEX

16 CERRADURAS INTERNO / INTERNO LOCKS

INTERNO	Cerraduras para interior <i>Locks for interior</i>	50
INTERNO ON/OFF	Cerraduras para interior con indicador de uso <i>Locks for interior with usage indicator</i>	51
INTERNO MODULAR	Cerraduras para interior <i>Locks for interior</i>	51

17 CERRADURAS PUERTA VAIVÉN INDIETRO / INDIETRO LOCKS FOR SWINGING GLASS DOORS

51

18 CERRADURAS PUERTA CORREDERA HOOK / HOOK LOCKS FOR SLIDING GLASS DOORS

52

19 CERRADURAS HORIZONTALES JANO / JANO HORIZONTAL LOCKS

52-53

20 CERRADURAS QUIPÓN TERRA / TERRA LOCKS "PUT ON - TAKE OFF"

TERRA	Cerraduras Quipón <i>"Put on - Take off" locks</i>	54
TERRA V12	Cerraduras Quipón para vidrio de 12mm <i>"Put on - Take off" locks for 12mm glass</i>	54

21 MANILLAS MODULAR / MODULAR HANDLES

54

22 CERRADEROS MEIA / MEIA STRIKE BOXES

MEIA	Cerraderos <i>Strike boxes</i>	55
INALTRONIC MEIA	Cerraderos electrónicos <i>Electronic strike boxes</i>	55
MEIA MINI	Cerraderos MINI <i>MINI strike boxes</i>	55

23 CERRADEROS ARES / TER / ARES / TER STRIKE BOXES

ARES / TER	Cerraderos petaca sin muesca <i>Flask strike boxes without slot</i>	55-56
INALTRONIC ARES / TER	Cerraderos electrónicos petaca sin muesca <i>Flask electronic strike boxes without slot</i>	57

ÍNDICE - INDEX

24 CERRADEROS 90° SCONTO / SCONTO STRIKE BOXES FOR 90°

SCONTO	Cerraderos 90° a presión <i>90° pressure strike boxes</i>	57
SCONTO	Cerraderos 90° con muesca <i>90° strike boxes with slot</i>	57

25 CERRADEROS PARA INTERIOR INTERNO / INTERNO STRIKE BOXES FOR INTERIOR

58

26 CERRADEROS PUERTA VAIVÉN INDIETRO / INDIETRO STRIKE BOXES FOR SWINGING DOORS

58

27 CERRADEROS PUERTA CORREDERA HOOK / HOOK STRIKE BOXES FOR SLIDING DOORS

58

28 CERRADEROS JANO / JANO STRIKE BOXES

59

29 CERRADEROS QUIPÓN TERRA / TERRA STRIKE BOXES "Put on - Take off"

59

30 CERRADEROS CARPINTERÍA WOOD / WOOD CARPENTRY STRIKE BOXES

60-61

31 CERRADEROS ELÉCTRICOS ARTICULATUS / ARTICULATUS ELECTRIC STRIKE BOXES

61

32 CUBRECABLES CELTA / CELTA CABLE COVER

61

33 CONTROLES DE ACCESO / ACCESS CONTROLS

ACCES	Controles de acceso <i>Access controls</i>	62
ENIQ APP	Controles de acceso <i>Access controls</i>	63
TAPKEY	Controles de acceso <i>Access controls</i>	64

ÍNDICE - INDEX

34 JUNTAS ESTANQUEIDAD Y PERFILERÍA / GASKETS FOR SHOWER BOX & PROFILES

AQUA	Juntas de estanqueidad <i>Gaskets for shower box</i>	65-66
PERIMETER	Perfilería inoxidable <i>Stainless-steel profiles</i>	66

35 TIRADORES / HANDLES

CIRCUM	Tiradores <i>Handles</i>	67-68
CUBITUS	Tiradores <i>Handles</i>	69-70
NORMA	Tiradores <i>Handles</i>	71

36 POMOS / KNOBS

72

37 MARQUESINAS / CANOPIES

COPERTA	Marquesinas <i>Canopies</i>	73
---------	--------------------------------	----

38 RECAMBIOS Y ACCESORIOS / SPARE PARTS AND ACCESSORIES

74-76

39 ARTÍCULOS DE REPOSICIÓN / REPLACEMENT ARTICLES

77-78

40 GLOSARIO DE ABREVIACIONES / GLOSSARY OF ABBREVIATIONS

79

41 CONDICIONES GENERALES DE VENTA Y GARANTÍA GENERAL SALES CONDITIONS AND GUARANTEE

80-82



1 PREVEN - SOPORTES MAMPARA / PREVEN - SCREEN SUPPORTS

C19L

SOPORTE MAMPARA SOBREMESA. Vidrio Laminado. 6 a 10 mm

DESKTOP SCREEN SUPPORT. Laminated glass. 6 to 10 mm



Ref.	Descripción/Description	IB	IS	NE / BL
C19L600	Soporte para altura de vidrio 600 mm Fitting for glass height up to 600 mm	35,75 €	34,02 €	31,69 €
C19L800	Soporte para altura de vidrio 800 mm Fitting for glass height up to 800 mm	39,99 €	38,04 €	36,33 €
C19L1000	Soporte para altura de vidrio 1000 mm Fitting for glass height up to 1000 mm	41,81 €	39,74 €	39,09 €

C19LTMA

SOPORTE MAMPARA MÓVIL ANTIVUELCO. Vidrio laminado templado o templado. 6 a 10 mm

ANTI-ROLL MOVABLE SCREEN SUPPORT. Tempered or tempered laminated glass. 6 to 10 mm



Ref.	Descripción/Description	NE/BL	PLATA RAL 9006
C19LTMA	Conjunto soporte mampara móvil antivuelco - Precio conjunto (2 soportes) Anti-roll movable screen support set - Price for set (2 supports)	372,24 €	372,24 €

C19LMA

SOPORTE MAMPARA MÓVIL ANTIVUELCO. Vidrio laminado. 8 o 10 mm

ANTI-ROLL MOVABLE SCREEN SUPPORT. Laminated glass. 8 or 10 mm



Ref.	Descripción/Description	NE/BL	PLATA RAL 9006
1800 V10	Conj. soporte mampara móvil anchura máxima vidrio 1800 mm - Espesor 10 mm Anti-roll movable screen support set, glass maximum width 1800 mm - Thickness 10 mm	565,22 €	565,22 €
1300 V10	Conj. soporte mampara móvil anchura máxima vidrio 1300 mm - Espesor 10 mm Anti-roll movable screen support set, glass maximum width 1300 mm - Thickness 10 mm	565,22 €	565,22 €
1800 V8	Conj. soporte mampara móvil anchura máxima vidrio 1800 mm - Espesor 8 mm Anti-roll movable screen support set, glass maximum width 1800 mm - Thickness 8 mm	565,22 €	565,22 €
1300 V8	Conj. soporte mampara móvil anchura máxima vidrio 1300 mm - Espesor 8 mm Anti-roll movable screen support set, glass maximum width 1300 mm - Thickness 8 mm	565,22 €	565,22 €

C19SP

SOPORTE PINZA MAMPARA para vidrio templado laminado – otros materiales. Vidrio: 6 a 10 mm

SCREEN CLAMP SUPPORT for tempered - laminate glass - other materials. Glass thickness: 6 to 10 mm







Ref.	Descripción/Description	IS-AN/IS	AN/IS
C19SP	Soporte pinza mampara Screen clamp support	44,12 €	■
C19PSP	Pata soporte pinza mampara Screen clamp support leg	■	30,73 €

2 BISAGRAS - HINGES







DECO

BISAGRA CON RETENCIÓN MECÁNICA, ALIENABLE Y TORNILLERÍA OCULTA. Vidrio 8/10mm
HINGES WITH MECHANICAL RETENTION, ALIGNABLE AND HIDDEN SCREWS. 8/10mm glass

Ref.	Descripción/Description	CB	NQS	NE
 DECO360	Simple 90° <i>Simple 90°</i>	64,88 €	62,85 €	70,73 €
 DECO362	Simple 90° esquina <i>Simple 90° corners</i>	64,88 €	62,85 €	70,73 €
 DECO363	Doble mismo plano <i>Double for the same plane</i>	114,44 €	108,21 €	128,17 €
 DECO365	Doble 90° <i>Double 90°</i>	133,51 €	126,24 €	149,53 €

BAR

BISAGRA CON RETENCIÓN MECÁNICA, ALINEABLE (AISI 316L - GRC5). Vidrio 8/10mm
HINGE WITH MECHANICAL RETENTION, ALIGNABLE (St. Steel 316L - GRC5). 8/10 mm glass

Ref.	Descripción/Description	IB	IS	BL/NE
 BAR360	Simple 90° <i>Simple 90°</i>	84,79 €	82,52 €	117,67 €
 BAR362	Simple 90° esquina <i>Simple 90° corners</i>	84,80 €	82,52 €	117,66 €
 BAR363	Doble mismo plano <i>Double for the same plane</i>	165,08 €	155,11 €	226,73 €
 BAR365	Doble 90° <i>Double 90°</i>	173,18 €	165,07 €	234,83 €
 BAR367	Doble mismo plano con vidrio central <i>Double in the same plane with central glass</i>	183,67 €	177,33 €	245,32 €
 BAR369	Bisagra hoja batiente <i>Batting hinge</i>	185,58 €	183,59 €	217,98 €

BB

BISAGRAS CON RETENCIÓN MECÁNICA (Base latón - GRC5). Vidrio 8/10mm
HINGES WITH MECHANICAL RETENTION (Brass base - GRC5) . 8/10 mm glass



Ref.	Descripción/Description	CB	NQS	BL/NE
BB	Simple 90° <i>Simple wall/glass 90°</i>	47,34 €	70,30 €	67,22 €
BB135°	Simple 135° <i>Simple wall/glass 135°</i>	56,34 €	81,52 €	80,01 €
BBE	Simple esquina 90° <i>Simple base displaced wall/glass 90°</i>	50,76 €	73,49 €	72,07 €
BBD	Doble 180° <i>Double glass/glass 180°</i>	97,06 €	159,38 €	121,33 €
BBD135°	Doble 135° <i>Double glass/glass 135°</i>	102,11 €	165,21 €	127,64 €
BBD90°	Doble 90° (tornillos exteriores) <i>Double glass/glass 90° (outside screws)</i>	105,84 €	173,10 €	132,30 €
BBP	Doble plegable 180° (sin retención) <i>Double for holding glass/glass 180° (without retention)</i>	106,19 €	165,72 €	132,73 €
BBD2	Doble 180° vidrio central <i>Double glass/glass 180° with central glass</i>	124,30 €	188,23 €	155,38 €
BBD90°-1	Doble 90° (tornillos interiores) <i>Double glass/glass 90° (inside screws)</i>	107,16 €	174,36 €	133,96 €

PICCOLO

BISAGRAS CON RETENCIÓN MECÁNICA (Base latón - GRC5). Vidrio 6/8mm
HINGES WITH MECHANICAL RETENTION (Brass base - GRC5) . 6/8 mm glass



Ref.	Descripción/Description	CB	NQS	BL/NE
360P	Simple 90° <i>Simple wall/glass 90°</i>	48,85 €	68,31 €	69,37 €
361P	Simple 135° <i>Simple wall/glass 135°</i>	58,10 €	77,53 €	82,50 €
362P	Simple esquina 90° <i>Simple base displaced wall/glass 90°</i>	53,38 €	72,29 €	75,80 €
363P	Doble 180° <i>Double glass/glass 180°</i>	94,07 €	161,63 €	117,59 €
364P	Doble 135° <i>Double glass/glass 135°</i>	100,73 €	166,16 €	125,92 €
365P	Doble 90° (tornillos exteriores) <i>Double glass/glass 90° (outside screws)</i>	100,84 €	180,13 €	126,05 €
366P	Doble plegable 180° (sin retención) <i>Double for holding glass/glass 180° (without retention)</i>	106,01 €	173,45 €	132,52 €
367P	Doble 180° vidrio central <i>Double glass/glass 180° with central glass</i>	123,39 €	189,23 €	154,24 €
368P	Doble 90° (tornillos interiores) <i>Double glass/glass 90° (inside screws)</i>	101,93 €	176,52 €	127,41 €

BEND

BISAGRA CON RETENCIÓN MECÁNICA PARA VIDRIO CURVADO V10mm
HINGE WITH MECHANICAL RETENTION FOR 10mm CURVED GLASS











Ref.	Descripción/Description	AN-PM	AN-IS	AN-NE
BEND360	Simple 90° <i>Simple wall/glass 90°</i>	344,79 €	344,79 €	344,79 €
BEND363	Doble 180° <i>Double wall/glass 180°</i>	753,24 €	753,24 €	753,24 €

No es posible el acabado AN-BR (anodizado brillo) / AN/BR Finish is not available (bright anodized)





SQUARE

BISAGRAS CON RETENCIÓN MECÁNICA (Base latón - GRC5). Vidrio 8/10mm
HINGES WITH MECHANICAL RETENTION (Brass base - GRC5). 8/10 mm glass

Ref.	Descripción/Description	CB	NQS	BL/NE
 360S	Simple 90° <i>Simple wall/glass 90°</i>	50,51 €	70,30 €	71,73 €
 361S	Simple 135° <i>Simple wall/glass 135°</i>	56,34 €	81,52 €	80,01 €
 362S	Simple esquina 90° <i>Simple base displaced wall/glass 90°</i>	50,76 €	73,51 €	72,07 €
 363S	Doble 180° <i>Double glass/glass 180°</i>	97,06 €	168,10 €	121,33 €
 364S	Doble 135° <i>Double glass/glass 135°</i>	102,11 €	174,23 €	127,64 €
 365S	Doble 90° (tornillos exteriores) <i>Double glass/glass 90° (outside screws)</i>	105,84 €	182,55 €	132,30 €
 366S	Doble plegable 180° (sin retención) <i>Double for holding glass/glass 180° (without retention)</i>	106,19 €	174,79 €	132,73 €
 367S	Doble 180° vidrio central <i>Double glass/glass 180° with central glass</i>	124,30 €	198,50 €	155,38 €
 368S	Doble 90° (tornillos interiores) <i>Double glass/glass 90° (inside screws)</i>	107,16 €	183,90 €	133,96 €

SQUARE V12



BISAGRAS CON RETENCIÓN MECÁNICA. Vidrio 12mm (Base latón - GRC5)
HINGES WITH MECHANICAL RETENTION. 12mm glass (Brass base - GRC5)

Ref.	Descripción/Description	CB	NQS	BL/NE
 360SV12	Simple 90° V12 <i>Simple wall/glass 90° V12</i>	57,05 €	76,84 €	81,51 €
 362SV12	Simple esquina 90° V12 <i>Simple base displaced wall/glass 90° V12</i>	58,76 €	77,51 €	82,20 €
 363SV12	Doble 180° V12 <i>Double glass/glass 180° V12</i>	106,13 €	177,19 €	185,49 €
 367SV12	Doble 180° vidrio central V12 <i>Double glass/glass 180° with central glass V12</i>	129,96 €	207,13 €	215,46 €

N

BISAGRAS SIN RETENCIÓN (Base latón - GRC5). Vidrio 8/10mm
HINGES WITHOUT RETENTION (Brass base - GRC5) 8/10mm glass

DIFERENTES ESPEORES DE VIDRIO..... CONSULTAR
FOR OTHER GLASS THICKNESS..... CONSULT

Ref.	Descripción/Description	CB	NQS	BL/NE
 124N	Doble plegable mismo plano <i>Double glass/glass for folding 180°</i>	75,68 €	83,13 €	94,59 €
 126N	Simple 90° <i>Simple 90°</i>	46,49 €	52,05 €	66,03 €

BG18

BISAGRAS SIN RETENCIÓN PARA GALCE (AISI 316 - GRC5) . Vidrio 8/10mm

HINGES WITHOUT RETENTION FOR REBATE DEPTH (AISI 316 - GRC5). 8/10mm glass

DIFERENTES ESPEORES DE VIDRIO..... CONSULTAR
FOR OTHER GLASS THICKNESS..... CONSULT



Ref.	Descripción/Description	GRC 5		
		IB	IS	BL/NE
Acero Inoxidable AISI 316L <i>AISI 316L Stainless Steel</i>				
BG18	Simple 90° , para marcos con galce de 35 a 40mm <i>Simple 90°, for frames with rebate depth from 35 to 40mm</i>	68,58 €	70,21 €	97,37 €

VESTA

BISAGRAS CON RETENCIÓN MECÁNICA (base latón o AISI 316L) . Vidrio 8/10mm

HINGES WITH MECHANICAL RETENTION (Brass or AISI 316L base). 8/10mm glass



Ref.	Descripción/Description	GRC 5					
		Base Latón <i>Brass base</i>			Acero Inoxidable AISI 316L <i>AISI 316L Stainless Steel</i>		
		CB	NQS	BL/NE	IB	IS	BL/NE
360V	Simple 90° <i>Simple wall/glass 90°</i>	39,72 €	59,05 €	56,41 €	44,20 €	43,68 €	60,88 €
362V	Simple esquina 90° <i>Simple base displaced wall/glass 90°</i>	39,72 €	59,05 €	56,41 €	44,20 €	43,68 €	60,88 €
363V	Doble 180° <i>Double glass/glass 180°</i>	80,65 €	98,64 €	100,81 €	84,79 €	83,26 €	104,96 €
365V	Doble 90° (tornillos exteriores) <i>Double glass/glass 90° (outside screws)</i>	89,01 €	107,07 €	111,26 €	99,07 €	97,17 €	121,32 €
368V	Doble 90° (tornillos interiores) <i>Double glass/glass 90° (inside screws)</i>	89,01 €	107,07 €	111,26 €	99,07 €	97,17 €	121,32 €
367V	Doble 180° con vidrio central <i>Double glass/glass 180° with central glas</i>	101,95 €	119,72 €	127,44 €	109,94 €	107,47 €	135,43 €

VESTA V12



BISAGRAS CON RETENCIÓN MECÁNICA - Vidrio 12mm (AISI 316L - GRC5)

HINGES WITH MECHANICAL RETENTION - 12mm glass (AISI 316L - GRC5)





Ref.	Descripción/Description	GRC 5		
		IB	IS	BL/NE
Acero Inoxidable AISI 316L <i>AISI 316L Stainless Steel</i>				
360V12	Simple 90° V12 <i>Simple wall/glass 90° V12</i>	50,77 €	50,25 €	72,09 €
362V12	Simple esquina 90° V12 <i>Simple base displaced wall/glass 90° V12</i>	50,77 €	50,25 €	72,09 €
363V12	Doble 180° V12 <i>Double glass/glass 180° V12</i>	91,35 €	89,83 €	114,19 €
365V12	Doble 90° (tornillos exteriores) V12 <i>Double glass/glass 90° (outside screws) V12</i>	105,65 €	103,73 €	132,06 €
368V12	Doble 90° (tornillos interiores) V12 <i>Double glass/glass 90° (inside screws) V12</i>	105,65 €	103,73 €	132,06 €
367V12	Doble 180° con vidrio central V12 <i>Double glass/glass 180° with central glass V12</i>	116,52 €	114,04 €	145,65 €



HIDROBI AT MARK III **BISAGRAS HIDRÁULICAS ALINEABLES CON TAPAS**
(GRC5-UNE EN 1670:2007/AC:2008) V8/10/12mm
ADJUSTABLE HYDRAULIC HINGES WITH COVERS
(GRC5-UNE EN 1670:2007/AC:2008) V8/10/12mm

Ref.	Descripción/Description	IB	IS	NE
 H2201AT	Base fijación centrada Mark III GRC 5 TAPAS Base with centered fastening Mark III GRC 5 COVERS	240,46 €	237,71 €	253,56 €
 H2202AT	Base fijación desplazada Mark III GRC 5 TAPAS Base with displaced fastening Mark III GRC 5 COVERS	240,46 €	237,71 €	253,56 €
 H2203AT	Doble mismo plano Mark III GRC 5 TAPAS Double glass/glass 180° Mark III GRC 5 COVERS	291,80 €	289,83 €	307,45 €

HIDROBI MAT MARK III **BISAGRAS ALINEABLES, RETENCION MECANICA CON TAPAS**
(GRC5-UNE EN 1670:2007/AC:2008) V8/10/12mm
ADJUSTABLE HINGES WITH MECHANICAL RETENTION AND COVERS
(GRC5-UNE EN 1670:2007/AC:2008) V8/10/12mm

Ref.	Descripción/Description	IB	IS	NE
 H2204AT	Base fijación centrada Mark III GRC 5 TAPAS Base with centered fastening Mark III GRC 5 COVERS	211,49 €	208,73 €	224,56 €
 H2205AT	Base fijación desplazada Mark III GRC 5 TAPAS Base with displaced fastening Mark III GRC 5 COVERS	211,49 €	208,73 €	224,56 €
 H2206AT	Doble mismo plano Mark III GRC 5 TAPAS Double glass/glass 180° Mark III GRC 5 COVERS	244,59 €	242,64 €	260,26 €

HIDROBI LT MARK III **BISAGRAS SIN RETENCIÓN CON TAPAS**
(GRC5-UNE EN 1670:2007/AC:2008) V8/10/12mm
HINGES WITHOUT RETENTION WITH COVERS
(GRC5-UNE EN 1670:2007/AC:2008) V8/10/12mm

Ref.	Descripción/Description	IB	IS	NE
 H2207AT	Base fijación centrada TAPAS Base with centered fastening COVERS	193,03 €	190,25 €	206,10 €
 H2208AT	Base fijación desplazada TAPAS Base with displaced fastening COVERS	193,03 €	190,25 €	206,10 €
 H2209AT	Doble mismo plano TAPAS Double glass/glass 180° COVERS	236,71 €	234,75 €	252,37 €

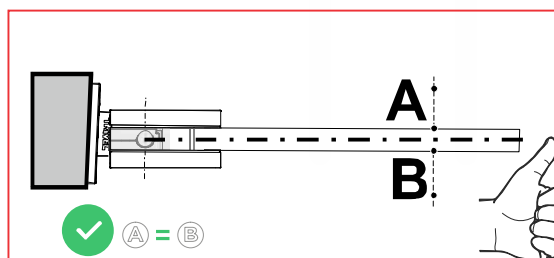
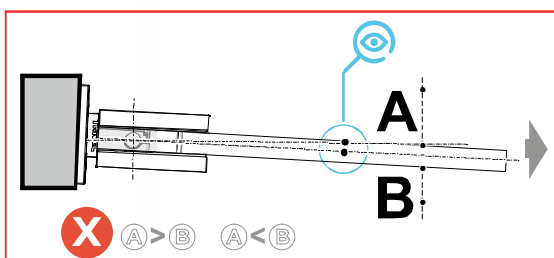

HIDROBI**BISAGRAS HIDRÁULICAS . Vidrio 8/10/12mm**
HYDRAULIC HINGES . 8/10/12mm glass

Ref.	Descripción/Description	AN-OBR	AN BR	AN IS	AN PM	AN/NE
H1201	Base fijación centrada <i>Base with centered fastening</i>	207,24 €	202,85 €	193,64 €	193,64 €	204,20 €
H1202	Base fijación desplazada <i>Base with displaced fastening</i>	207,24 €	202,85 €	193,64 €	193,64 €	204,20 €
H1203	Doble mismo plano <i>Double glass/glass 180°</i>	264,18 €	255,41 €	244,72 €	244,72 €	261,02 €

HIDROBI L**BISAGRAS SIN RETENCIÓN . Vidrio 8/10/12mm**
HINGES WITHOUT RETENTION. 8/10/12mm glass

Ref.	Descripción/Description	AN-OBR	AN BR	AN IS	AN PM	AN/NE
H1207	Base fijación centrada <i>Base with centered fastening</i>	165,21 €	160,81 €	151,58 €	151,58 €	162,15 €
H1208	Base fijación desplazada <i>Base with displaced fastening</i>	165,21 €	160,81 €	151,58 €	151,58 €	162,15 €
H1209	Doble mismo plano <i>Double glass/glass 180°</i>	212,18 €	203,42 €	192,72 €	192,72 €	211,32 €

HIDROBI M**BISAGRAS CON RETENCIÓN MECÁNICA . Vidrio 8/10/12mm**
HINGES WITH MECHANICAL RETENTION. 8/10/12mm glass

Ref.	Descripción/Description	AN-OBR	AN BR	AN IS	AN PM	AN/NE
H1204	Base fijación centrada <i>Base with centered fastening</i>	186,31 €	181,91 €	172,69 €	172,69 €	175,22 €
H1205	Base fijación desplazada <i>Base with displaced fastening</i>	186,31 €	181,91 €	172,69 €	172,69 €	175,22 €
H1206	Doble mismo plano <i>Double glass/glass 180°</i>	233,56 €	224,79 €	211,14 €	211,14 €	213,82 €



Bisagras hidráulicas HIDROBI Mark III, específicas para instalaciones en ambientes de alta corrosión, Saunas, Piscinas, Hammam... según Norma UNE EN 1670:2007/AC:2008, Grado 5

Hydraulic hinges HIDROBI MARK III, specific for installations with high corrosion environments like saunas, swimming pools, Hammams... according to the Standard UNE EN 1670:2007/AC:2008, Grade 5

HIDROBI MARK III

BISAGRAS HIDRÁULICAS (GRC5 - UNE EN 1670:2007/AC:2008) . Vidrio 8/10/12mm
HYDRAULIC HINGES (GRC5 - UNE EN 1670:2007/AC:2008). 8/10/12mm glass



Ref.	Descripción/Description	AN-OBR	AN BR	AN IS	AN PM	AN/NE
H2201	Base fijación centrada Mark III GRC 5 <i>Base with centered fastening Mark III GRC 5</i>	218,60 €	214,22 €	204,20 €	204,20 €	204,20 €
H2202	Base fijación desplazada Mark III GRC 5 <i>Base with displaced fastening Mark III GRC 5</i>	218,60 €	214,22 €	204,20 €	204,20 €	204,20 €
H2203	Doble mismo plano Mark III GRC 5 <i>Double glass/glass 180º Mark III GRC 5</i>	279,85 €	271,09 €	261,02 €	261,02 €	261,02 €

HIDROBI L MARK III

BISAGRAS SIN RETENCIÓN (GRC5-UNE EN 1670:2007/AC:2008) . Vidrio 8/10/12mm
HINGES WITHOUT RETENTION (GRC5-UNE EN 1670:2007/AC:2008). 8/10/12mm glass



Ref.	Descripción/Description	AN-OBR	AN BR	AN IS	AN PM	AN/NE
H2207	Base fijación centrada <i>Base with centered fastening</i>	176,56 €	172,17 €	162,15 €	162,15 €	162,15 €
H2208	Base fijación desplazada <i>Base with displaced fastening</i>	176,56 €	172,17 €	162,15 €	162,15 €	162,15 €
H2209	Doble mismo plano <i>Double glass/glass 180º</i>	230,16 €	221,39 €	211,32 €	211,32 €	211,32 €

HIDROBI M MARK III

BISAGRAS CON RETENCIÓN MECÁNICA (GRC5 - UNE EN 1670:2007/AC:2008)
Vidrio 8/10/12mm
HINGES WITH RETENTION (GRC5-UNE EN 1670:2007/AC:2008). 8/10/12mm glass



Ref.	Descripción/Description	AN-OBR	AN BR	AN IS	AN PM	AN/NE
H2204	Base fijación centrada <i>Base with centered fastening</i>	189,62 €	185,24 €	175,22 €	175,22 €	175,22 €
H2205	Base fijación desplazada <i>Base with displaced fastening</i>	189,62 €	185,24 €	175,22 €	175,22 €	175,22 €
H2206	Doble mismo plano <i>Double glass/glass 180º</i>	232,66 €	223,89 €	213,82 €	213,82 €	213,82 €

SUPLEMENTO PARA ESPESORES DE VIDRIO ESPECIALES EN BISAGRAS HIDROBI

SUPPLEMENT FOR SPECIAL GLASS THICKNESSES IN *BISAGRAS HIDROBI*

Suplemento para vidrio de ≥13 a 16mm
Supplement for glass from ≥13 to 16mm

30,63 €

Suplemento para vidrio de ≥17 a 22mm
Supplement for glass from ≥17 to 22mm

34,75 €



Solicitar en el pedido la referencia + V espesor de vidrio + acabado Ej: H1201V18 AN PM
Request the reference + glass thickness + finish in the order Ex: H120 V1 18 AN PM

* **NOTA:** Disponibilidad de acabados en ANODIZADO en varios colores para todas las bisagras HIDROBI.

* **NOTE:** Availability of finishes in ANODIZED, in various colours for all the HIDROBI hydraulic hinges.



Contacte con nosotros
Contact us

3 PERNIOS HIDRÁULICOS / HYDRAULIC PATCH FITTINGS

OTROS ACABADOS..... CONSULTAR
OTHER FINISHES..... CONSULT

G100E

KIT PERNIO HIDRÁULICO PARA PUERTAS DE EXTERIOR
HYDRAULIC PATCH FITTING KIT FOR EXTERIOR DOORS



Ref.	Descripción/Description	IB	IS	NE
G100E	KIT Pernio Hidráulico + Punto Giro + Pernio Alto <i>Hydraulic patch kit + Top pivot + Top patch fitting</i>	272,63 €	260,74 €	315,41 €

G100EA

KIT PERNIO HIDRÁULICO PARA PUERTAS DE EXTERIOR
HYDRAULIC PATCH FITTING KIT FOR EXTERIOR DOORS

PARA INSTALAR CON SERIE MAJESTIC (STC) /
TO INSTALL WITH MAJESTIC SERIES (STC)
Pernio alto H1001 / H1001 Top patch fitting
Punto de giro montante H1003 / H1003 Upright point
Punto de giro lateral montante H1004 / H1004 Upright lateral turning point



Ref.	Descripción/Description	IB	IS	NE
G100EA	KIT Pernio Hidráulico + Punto Giro <i>Hydraulic patch kit + Top pivot</i>	266,75 €	254,85 €	308,23 €

G100

KIT PERNIO HIDRÁULICO
HYDRAULIC PATCH FITTING KIT



Ref.	Descripción/Description	IB	IS	NE
G100	KIT Pernio Hidráulico + Punto Giro + Pernio Alto <i>Hydraulic patch kit + Top pivot + Top patch fitting</i>	213,91 €	202,02 €	256,70 €

G100A

KIT PERNIO HIDRÁULICO
HYDRAULIC PATCH FITTING KIT

PARA INSTALAR CON SERIE GT / TO INSTALL WITH GT SERIES

Pernio alto GT901 / GT901 Top patch fitting
Punto de giro montante GT903 / GT903 Upright point
Punto de giro lateral montante GT904 / GT904 Upright lateral turning point

PARA INSTALAR CON SERIE MAJESTIC (STC) /
TO INSTALL WITH MAJESTIC SERIES (STC)

Pernio alto H1001 / H1001 Top patch fitting
Punto de giro montante H1003 / H1003 Upright point
Punto de giro lateral montante H1004 / H1004 Upright lateral turning point



Ref.	Descripción/Description	IB	IS	NE
G100A	KIT Pernio Hidráulico + Punto Giro <i>Hydraulic patch kit + Top pivot</i>	208,03 €	196,13 €	249,64 €

4 CIERRAPUERTAS / FLOOR SPRINGS

ESPLUGUES

CIERRAPUERTAS (3 velocidades) FLOOR SPRINGS (3 speeds)

NUEVO RESTYLING

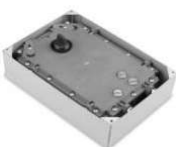
Ref.	Descripción/Description	IB
 <p>1R - 2R - 3R - 10R 1C - 2C - 3C - 10C 1CI - 2CI - 3CI - 4CI 1E - 2E - 3E - 10E</p>	<p>Estándar bloqueo 90° Standard retention to 90°</p>	138,18 €
 <p>SR</p>	<p>Sin retención a 90° Without retention to 90°</p> <p>Bajo pedido Under request</p>	147,04 €
<p>VG</p>	<p>Variación grados (máximo 130°) Degree variation (max. 130°)</p> <p>Bajo pedido Under request</p>	188,92 €

R



Regleta
Strip Pivot

C



Cuadradillo 16/19
Square Pivot 16/19

CI



Cuadradillo 13/16
Square Pivot 13/16

E



Europeo
European Pivot



AZUL – Fuerza 1:

Ancho de la puerta de 95 cm a 110 cm alto 250 cm.
Peso máximo aconsejable de la puerta 80 kg
Fuerza máxima aproximada de retención 43 nw

Width of the door from 95cm to 110cm, and height of 250cm.
Maximum recommended weight of the door 80Kg
Approximate maximum retention force of 43nw

Largeur de la porte de 95cm à 110cm, hauteur 250cm.
Poids maximum recommandé de la porte 80Kg
Force de retenue maximale approximative de 43nw



VERDE – Fuerza 2:

Ancho de la puerta de 80 cm a 95 cm alto 250 cm
Peso máximo aconsejable de la puerta 70 kg
Fuerza máxima aproximada de retención 36 nw

Width of the door from 80cm to 95cm, and height of 250cm.
Maximum recommended weight of the door 70Kg
Approximate maximum retention force of 36nw

Largeur de la porte de 80cm à 95cm, hauteur 250cm.
Poids maximum recommandé de la porte 70Kg
Force de retenue maximale approximative de 36nw



AMARILLO – Fuerza 3:

Ancho de la puerta menos de 80 cm alto 250 cm
Peso máximo aconsejable de la puerta 55 kg
Fuerza máxima aproximada de retención 35 nw

Width of the door less than 80cm, and height of 250cm.
Maximum recommended weight of the door 55Kg
Approximate maximum retention force of 35nw

Largeur de la porte 80cm, hauteur 250cm.
Poids maximum recommandé de la porte 55Kg
Force de retenue maximale approximative de 35nw



ROJO – Fuerza 10:

Ancho de la puerta de 110 cm a 125 cm alto 250 cm
Peso máximo aconsejable de la puerta 100 kg
Fuerza máxima aproximada de retención 46 nw

Width of the door from 110cm to 125cm, and height of 250cm.
Maximum recommended weight of the door 100Kg
Approximate maximum retention force of 46nw

Largeur de la porte de 110cm à 125cm, hauteur 250cm.
Poids maximum recommandé de la porte 100Kg
Force de retenue maximale approximative de 46nw

NUEVO RESTYLING CIERRAPUERTAS ESPLUGUES





FÁCIL DE IDENTIFICAR PARA UNA RÁPIDA INSTALACIÓN Y MANTENIMIENTO

Además, las nuevas tapas vienen identificadas con el tipo de leva mediante un círculo marcado, e indican si se trata de alguna variación especial: sin retención o variación de grados.

EL CÍRCULO MARCADO IDENTIFICA FUNCIÓN ESPECIAL

-  VG - VARIACIÓN GRADOS
-  SR - SIN RETENCIÓN

EL CÍRCULO MARCADO IDENTIFICA EL TIPO DE LEVA

-  R REGLETA
-  C CUADRADILLO 16/19
-  CI CUADRADILLO 13/16
-  E EUROPEO
-  M MODERNO

3 VELOCIDADES

- 1 VELOCIDAD APROXIMACIÓN
- 2 VELOCIDAD CIERRE
- 3 CIERRE RESBALÓN

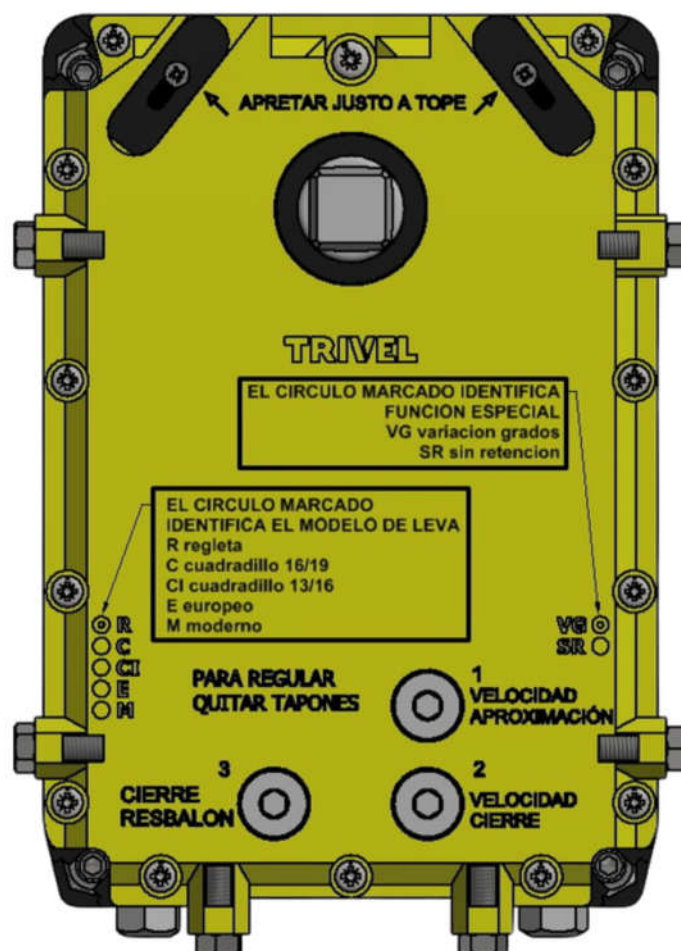
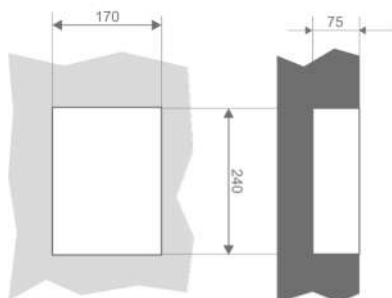

CARACTERÍSTICAS GENERALES:

- Fabricados con materiales anti corrosión.
- Mecanismo provisto de tres velocidades de cierre para cerraduras de picaporte /resbalón.
- Fluido hidráulico termo constante. Punto de inflamación 160°, punto de congelación -40°.
- Gran posibilidad de regulación dentro de la caja metálica, alto, ancho, alto y diagonalmente.
- Bloqueo estándar a 90°.
- Certificado por norma UNE-EN 1154:2003/AC 2006 Grado 8 (500.000 ciclos).
- Acabados tapa embellecedora:
Inoxidable brillo o satinado, bajo pedido otros colores y acabados.

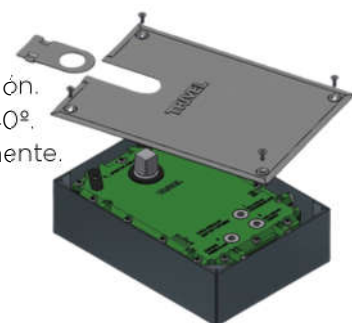

G75

CIERRAPUERTAS
FLOOR SPRINGS

Ref.	Descripción/Description	IB/IS	NE
G75R	Cierrapuertas standard bloqueo 90° <i>Standard floor spring retention at 90°</i>	95,92 €	125,98 €
G75C	Cierrapuertas standard bloqueo 90° <i>Standard floor spring retention at 90°</i>	95,92 €	125,98 €
G75C200	Cierrapuertas 200 Kg CUADRADILLO 16/19 bloqueo 90° <i>Floor spring retention to 90° 200Kg (square16/19mm)</i>	140,08 €	170,13 €



G75R regleta
G75C strip pivot



G75C cuadradillo 16/19
G75C square pivot 16/19

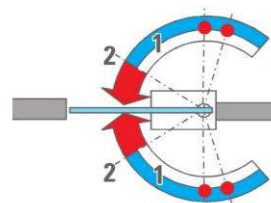
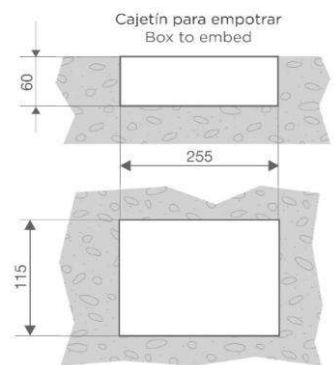
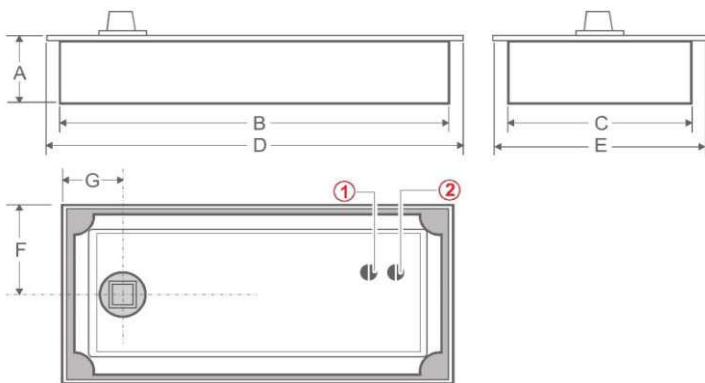



















1. Velocidad de aproximación de 90° a 25°. Approach speed from 90° to 25°.
2. Velocidad de cierre de 25° a 0°. Closure speed from 25° to 0°.

A	B	C	D	E	F	G	Ancho máx. puerta Max. width door (mm)	Peso máx. puerta Max. weight door (Kg)
55	250	110	270	135	55	55-65	1100	100

5 HERRAJES / FITTINGS















GT

HERRAJES REGULABLES . Vidrio 10 mm
ADJUSTABLE PATCH FITTINGS . 10 mm glass

Ref.	Descripción / Description	IB/IS	BL/NE
 GT900	Punto de giro <i>Top pivot</i>	9,25 €	13,59 €
 GT901	Pernio alto regulable <i>Top patch with adjustable spindle</i>	36,98 €	54,36 €
 GT901D	Pernio alto regulable desplazable <i>Top patch with adjustable and moveable spindle</i>	38,71 €	56,91 €
 GT902C	Pernio bajo regulable cuadradillo 16/19 <i>Bottom patch with adjustable spindle 16/19</i>	36,75 €	54,02 €
 GT902E	Pernio bajo regulable europeo <i>Bottom patch with adjustable European spindle</i>	35,59 €	52,31 €
 GT902ED	Pernio bajo regulable europeo desplazable <i>Bottom patch with adjustable and moveable European spindle</i>	38,24 €	56,21 €
 GT902R	Pernio bajo regulable regleta <i>Bottom patch with adjustable spindle</i>	36,69 €	53,93 €
 GT902CD	Pernio bajo regulable cuadradillo 16/19 desplazable <i>Bottom patch with adjustable and moveable spindle 16/19</i>	38,71 €	56,91 €
 GT902RD	Pernio bajo regulable regleta desplazable <i>Bottom patch with adjustable and moveable spindle</i>	38,39 €	56,44 €
 GT903	Punto de giro montante regulable <i>Overpanel patch with fixing plate adjustable pivot point</i>	44,79 €	65,84 €
 GT903D	Punto de giro montante regulable desplazable <i>Overpanel patch with adjustable and moveable pivot point</i>	40,59 €	59,67 €
 GT904	Punto de giro lateral montante regulable <i>Patch for overpanel and side panel with adjustable pivot point</i>	60,76 €	89,32 €
 GT904C	Punto de giro lateral montante regulable ciego <i>Patch for overpanel and side panel with blind adjustable pivot point</i>	66,83 €	95,37 €
 GT905	Punto de giro lateral montante regulable con contrafuerte <i>Patch for overpanel and side panel with fin fitting and adjustable pivot point</i>	85,47 €	125,64 €
 GT906	Unión una luna <i>Connector</i>	19,72 €	29,00 €
 GT907	Unión una luna vértices <i>Connector (vertex)</i>	21,57 €	31,72 €
 GT908	Unión dos lunas <i>Connector glass/glass</i>	23,70 €	34,84 €
 GT909	Unión dos lunas puerta corredera <i>Connector glass/glass for sliding door</i>	27,57 €	40,53 €

















GT

HERRAJES REGULABLES . Vidrio 10 mm
ADJUSTABLE PATCH FITTINGS . 10 mm glass

Ref.	Descripción / Description	IB/ IS	BL/NE
 GT910	Unión tres lunas <i>Connector glass doors</i>	35,83 €	52,67 €
 GT910C	Unión tres lunas ciego <i>Blind connector glass doors</i>	39,41 €	56,25 €
 GT911	Unión tres lunas tope <i>Connector glass doors with stopper</i>	36,79 €	54,09 €
 GT912	Unión cuatro lunas <i>Connector glass doors</i>	34,17 €	50,23 €
 GT914	Unión tres lunas con contrafuerte <i>Connector glass doors with fin fitting</i>	57,75 €	84,90 €
 GT916	Unión dos lunas con contrafuerte <i>Connector glass/ glass with fin fitting</i>	47,50 €	69,82 €
 GT917	Unión dos lunas ángulo 90° <i>Connector glass/ glass with angle 90°</i>	56,81 €	83,52 €
 GT918	Unión dos lunas ángulo 90° suelo/techo <i>Connector glass/ glass with angle 90° floor/ceiling</i>	51,60 €	75,85 €
 GT919	Unión tres lunas ángulo 90° <i>Connector glass doors with angle 90°</i>	71,80 €	105,56 €
 GT920	Unión tres lunas tope ángulo 90° <i>Connector glass doors with angle 90° and stopper</i>	71,46 €	105,05 €
 GT921	Unión cuatro lunas ángulo 90° <i>Connector glass doors with angle 90°</i>	62,93 €	92,52 €
 GT922	Punto de giro lateral montante ángulo 90° <i>Patch for overpanel and side panel with angle 90°</i>	88,22 €	129,67 €
 GT924	Unión dos lunas vertical <i>Vertical connector glass/ glass</i>	25,36 €	37,29 €
 GT925	Unión una luna sin anclaje interior <i>Connector glass door</i>	22,99 €	33,81 €
 GT926	Punto de giro montante regulable doble batería puertas <i>Double overpanel patch for glass doors</i>	68,78 €	101,11 €





















GT V12

HERRAJES REGULABLES. Vidrio 12 mm
ADJUSTABLE PATCH FITTINGS. 12 mm glass

Ref.	Descripción / Description	IB/ IS
 GT901V12	Pernio alto regulable V12 <i>Top patch with adjustable spindle</i>	47,27 €
 GT901DV12	Pernio alto regulable desplazable V12 <i>Top patch with adjustable and moveable spindle</i>	48,88 €
 GT902CV12	Pernio bajo regulable cuadradillo 16/19 V12 <i>Bottom patch with adjustable spindle 16/19</i>	46,98 €
 GT902EV12	Pernio bajo regulable europeo V12 <i>Bottom patch with adjustable European spindle</i>	45,85 €
 GT902EDV12	Pernio bajo regulable europeo desplazable V12 <i>Bottom patch with adjustable European spindle</i>	48,48 €
 GT902RV12	Pernio bajo regulable regleta V12 <i>Bottom patch with adjustable spindle</i>	46,95 €
 GT902CDV12	Pernio bajo regulable cuadradillo 16/19 desplazable V12 <i>Bottom patch with adjustable and moveable spindle 16/19</i>	48,91 €
 GT902RDV12	Pernio bajo regulable regleta desplazable V12 <i>Bottom patch with adjustable and moveable spindle</i>	48,57 €
 GT903V12	Punto de giro montante regulable V12 <i>Overpanel patch with fixing plate adjustable pivot point</i>	55,10 €
 GT903DV12	Punto de giro montante regulable desplazable V12 <i>Overpanel patch with adjustable and moveable pivot point</i>	50,98 €
 GT904V12	Punto de giro lateral montante regulable V12 <i>Patch for overpanel and side panel with adjustable pivot point</i>	71,05 €
 GT904CV12	Punto de giro lateral montante ciego regulable V12 <i>Patch for overpanel and side panel with blind adjustable pivot point</i>	FALTA PREU
 GT906V12	Unión una luna V12 <i>Connector</i>	19,72 €
 GT908V12	Unión dos lunas V12 <i>Connector</i>	23,70 €
 GT910V12	Unión tres lunas V12 <i>Connector</i>	35,83 €
 GT910CV12	Unión tres lunas ciego V12 <i>Blind connector</i>	39,41 €
 GT912V12	Unión cuatro lunas V12 <i>Connector glass doors</i>	35,02 €





















MILLENNIUM

HERRAJES . Vidrio 10 mm
PATCH FITTINGS . 10 mm glass

Ref.	Descripción / Description	IB/ IS	BL/NE
 301M	Pernio alto <i>Top patch</i>	30,43 €	44,73 €
 302M	Pernio bajo regleta doble <i>Bottom patch with double spindle</i>	46,08 €	67,73 €
 303M	Punto de giro superior para 301M <i>Top pivot for 301M</i>	8,55 €	12,57 €
 304M	Punto de giro montante <i>Overpanel patch with fixing plate</i>	44,79 €	65,84 €
 305M	Punto de giro lateral montante <i>Patch for overpanel and side panel</i>	45,53 €	66,93 €
 306M	Punto de giro lateral montante ángulo 90° <i>Patch for overpanel and side panel angle 90°</i>	95,28 €	140,06 €
 307M	Punto de giro lateral montante con contrafuerte <i>Patch for overpanel and side panel with fin fitting</i>	69,04 €	101,50 €
 308M	Unión una luna <i>Connector</i>	23,73 €	34,88 €
 309M	Unión dos lunas <i>Connector glass/ glass</i>	26,60 €	39,10 €
 310M	Unión dos lunas tope <i>Connector glass/ glass with stopper</i>	37,99 €	55,83 €
 311M	Unión dos lunas ángulo 90° <i>Connector glass/ glass angle 90°</i>	72,47 €	106,53 €
 311MS	Unión dos lunas ángulo 90° suelo/techo <i>Connector glass/ glass angle 90° floor/ceiling</i>	55,15 €	81,12 €
 312M	Unión dos lunas con contrafuerte <i>Connector glass/ glass with fin fitting</i>	50,58 €	74,35 €
 313M	Unión puerta corredera <i>Connector glass/ glass for sliding door</i>	26,56 €	39,04 €
 314M	Unión tres lunas <i>Connector glass doors</i>	36,94 €	54,31 €
 315M	Unión tres lunas ángulo 90° <i>Connector glass doors angle 90°</i>	79,52 €	116,89 €
 317M	Unión tres lunas tope <i>Connector glass doors with stopper</i>	39,03 €	57,37 €
 318M	Unión tres lunas tope ángulo 90° <i>Connector glass doors angle 90° with stopper</i>	76,27 €	112,11 €
 320M	Unión cuatro lunas <i>Connector glass doors</i>	36,66 €	53,89 €
 321M	Unión cuatro lunas ángulo 90° <i>Connector glass doors angle 90°</i>	66,93 €	98,39 €





















MILLENNIUM

HERRAJES . Vidrio 10 mm
PATCH FITTINGS . 10 mm glass

Ref.	Descripción / Description	IB/ IS	BL/NE
 322M	Punto de giro montante desplazable <i>Overpanel moveable</i>	46,13 €	67,81 €
 323M	Pernio alto regulable <i>Top patch with adjustable spindle</i>	34,14 €	50,19 €
 324M	Pernio bajo regulable cuadradillo 16/19 <i>Bottom patch with adjustable spindle 16/19</i>	39,62 €	58,25 €
 325M	Pernio bajo regulable regleta <i>Bottom patch with adjustable spindle</i>	39,58 €	58,18 €
 326M	Pernio bajo regulable europeo <i>Bottom patch with adjustable European spindle</i>	38,40 €	56,45 €
 327M	Unión dos lunas vertical <i>Vertical connector glass/ glass</i>	28,27 €	41,56 €
 329M	Punto de giro superior para 323M <i>Top pivot for 323M</i>	8,62 €	12,66 €
 331M	Unión una luna sin anclaje interior <i>Connector</i>	23,70 €	34,84 €
 332M	Punto de giro montante doble en batería puertas <i>Double overpanel patch for glass doors</i>	67,32 €	98,95 €
 333M	Pernio bajo cuadradillo 16/19 giro desplazado <i>Bottom patch with bushing displaced</i>	89,38 €	131,39 €
 334M	Pernio alto giro desplazado <i>Top patch with bushing displaced</i>	88,15 €	129,58 €
 335M	Punto de giro montante desplazado <i>Overpanel patch displaced</i>	90,12 €	132,48 €
 336M	Punto de giro lateral montante giro desplazado <i>Overpanel & side panel with bushing displaced</i>	90,87 €	133,59 €
 337M	Pernio bajo cuadradillo 16/19 giro desplazado y desplazable <i>Bottom patch with bushing displaced and moveable</i>	94,07 €	138,29 €
 338M	Pernio alto giro desplazado y desplazable <i>Top patch with bushing displaced and moveable</i>	92,20 €	135,53 €
 339M	Punto de giro montante giro desplazado y desplazable <i>Overpanel displaced and moveable</i>	94,18 €	138,45 €
 340M	Pernio alto regulable desplazable <i>Top patch adjustable and moveable</i>	35,27 €	51,84 €
 341M	Pernio bajo regulable desplazable cuadradillo 16/19 <i>Bottom patch adjustable and moveable</i>	40,36 €	59,33 €
 342M	Pernio bajo regleta regulable desplazable <i>Bottom patch adjustable and moveable</i>	40,67 €	59,77 €
 343M	Pernio bajo regulable desplazable europeo <i>European bottom patch adjustable and moveable</i>	40,36 €	59,33 €





















N

HERRAJES . Vidrio 10 mm
PATCH FITTINGS . 10 mm glass

Ref.	Descripción / Description	IB	IS	BL/NE
 101N	Pernio alto <i>Top patch</i>	33,32 €	23,73 €	48,99 €
 101NR	Pernio alto reforzado <i>Reinforced top patch</i>	56,72 €	45,53 €	83,38 €
 1032	Pernio bajo regleta <i>Bottom patch</i>	33,23 €	30,29 €	48,85 €
 1032R	Pernio bajo regleta reforzado <i>Reinforced bottom patch</i>	67,77 €	64,88 €	99,62 €
 130N	Punto de giro montante pared <i>Overpanel patch for fixing to wall</i>	34,96 €	30,64 €	51,38 €
 141N	Pernio alto para giro desplazado <i>Top patch for bushing displaced</i>	66,99 €	61,54 €	98,48 €
 142N	Pernio bajo cuadradillo 16/19 para giro desplazado <i>Bottom patch for bushing displaced</i>	79,07 €	76,75 €	116,22 €
 401N	Punto de giro lateral montante <i>Overpanel and side panel patch</i>	57,80 €	46,03 €	84,98 €
 401N90º	Punto de giro lateral montante ángulo 90º <i>Overpanel and side panel patch angle 90º</i>	64,05 €	58,37 €	94,15 €
 401NC	Punto de giro lateral montante taladros ciegos <i>Overpanel and side panel patch with blind drills</i>	52,20 €	44,50 €	76,74 €
 401NC90º	Punto de giro lateral montante taladros ciegos ángulo 90º <i>Overpanel and side panel patch with blind drills angle 90º</i>	65,49 €	55,74 €	96,27 €
 403N	Punto de giro montante <i>Overpanel patch</i>	40,28 €	33,83 €	59,21 €
 403N/2	Punto de giro montante desplazado <i>Overpanel patch displaced</i>	37,09 €	30,56 €	54,51 €
 404N	Punto de giro montante en batería de puertas <i>Overpanel patch glass/ glass</i>	42,06 €	34,64 €	61,82 €
 409N	Punto de giro montante aleta <i>Overpanel patch with fixing plate</i>	40,61 €	35,00 €	59,71 €
 420N	Punto de giro montante doble en batería de puertas <i>Double overpanel patch glass/ glass</i>	56,74 €	44,34 €	83,41 €
 431N	Punto de giro lateral montante con contrafuerte <i>Patch for overpanel and side panel with fin fitting</i>	83,18 €	68,44 €	122,28 €
 440N	Punto de giro superior para 141N <i>Top patch for 141N</i>	24,95 €	24,63 €	36,67 €
 441N	Punto de giro lateral montante giro desplazado para 141N <i>Overpanel and side panel patch to displace for 141N</i>	75,07 €	66,75 €	110,35 €
 442N	Punto de giro montante giro desplazado para 141N <i>Overpanel patch displaced for 141N</i>	74,32 €	67,45 €	109,25 €

N

HERRAJES . Vidrio 10 mm
PATCH FITTINGS . 10 mm glass

Ref.	Descripción / Description	IB	IS	BL/NE
 452N	Punto de giro superior para 101N <i>Top patch for 101N</i>	9,10 €	7,48 €	13,37 €
 463C	Tejuelo cuadradillo 16/19 <i>Bottom square pivot pin 16/19</i>	20,04 €	18,09 €	29,46 €
 463CI	Tejuelo cuadradillo 13/16 <i>Bottom Italian pivot pin 13/16</i>	15,92 €	15,10 €	23,39 €
 463N	Tejuelo regleta <i>Bottom pivot</i>	19,08 €	17,98 €	28,04 €
 463E	Tejuelo europeo <i>Bottom European pivot</i>	21,22 €	21,22 €	31,19 €
 505N	Unión dos lunas vertical <i>Vertical connector glass/ glass</i>	26,40 €	20,66 €	40,14 €
 514N	Unión cuatro lunas <i>Connector for glass doors</i>	32,01 €	24,64 €	47,06 €
 514N90º	Unión cuatro lunas ángulo 90º <i>Connector for glass doors angle 90º</i>	37,14 €	31,46 €	54,60 €
 519N	Unión tres lunas tope <i>Connector for glass doors with stopper</i>	30,92 €	23,18 €	45,46 €
 519N90º	Unión tres lunas tope ángulo 90º <i>Connector for glass doors angle 90º with stopper</i>	38,48 €	30,72 €	56,57 €
 519NC	Unión tres lunas tope taladros ciegos <i>Connector for glass doors with stopper and blind drills</i>	29,93 €	23,90 €	44,00 €
 521N	Unión tres lunas <i>Connector for glass doors</i>	31,90 €	24,88 €	46,90 €
 521N90º	Unión tres lunas ángulo 90º <i>Connector for glass doors angle 90º</i>	38,68 €	31,84 €	56,86 €
 521NC	Unión tres lunas taladros ciegos <i>Connector for glass doors with blind drills</i>	29,21 €	22,35 €	42,94 €
 555N	Unión una luna <i>Connector patch</i>	23,43 €	19,63 €	34,45 €
 555NE	Unión una luna taladros anclaje en aleta exterior <i>Connector patch with drills and outside plate</i>	20,88 €	17,08 €	30,68 €
 555S	Unión una luna suelo/techo <i>Connector floor/ ceiling</i>	20,06 €	17,61 €	29,48 €
 555V	Unión una luna vértices <i>Connector (vertex)</i>	30,46 €	26,65 €	44,77 €
 571N	Unión dos lunas <i>Connector glass/ glass</i>	21,84 €	15,31 €	32,10 €
 753N	Contrafuerte <i>Fin fitting</i>	22,04 €	18,29 €	32,40 €

N V12



















HERRAJES. Vidrio 12 mm
PATCH FITTINGS. 12 mm glass



Ref.	Descripción / Description	IB	IS	NE
101NV12	Pernio alto V12 <i>Top patch</i>	42,06 €	33,04 €	56,61 €
1032V12	Pernio bajo regleta V12 <i>Bottom patch</i>	42,92 €	39,62 €	56,47 €
401NV12	Punto de giro lateral montante V12 <i>Overpanel and side panel patch</i>	73,98 €	62,48 €	99,11 €
403NV12	Punto de giro montante V12 <i>Overpanel patch</i>	48,92 €	42,60 €	66,74 €
409NV12	Punto de giro montante aleta V12 <i>Overpanel patch with fixing plate</i>	49,24 €	43,69 €	67,22 €
521NV12	Unión tres lunas V12 <i>Connector patch</i>	31,90 €	24,88 €	45,83 €
555NV12	Unión una luna V12 <i>Connector patch</i>	23,43 €	19,63 €	34,38 €
101NRV12	Pernio alto reforzado V12 <i>Reinforced top patch</i>	59,44 €	48,63 €	83,87 €
1032RV12	Pernio bajo regleta reforzado V12 <i>Reinforced bottom patch</i>	71,57 €	68,03 €	95,51 €













T

HERRAJES Y ACCESORIOS
FITTINGS AND ACCESSORIES

Ref.	Descripción / Description	CB	IB	IS	BL/NE
 A1A2	Unión ángulo 90° <i>Connector glass/ glass angle 90°</i>	■	30,90 €	24,77 €	45,42 €
 A1A2S	Unión ángulo 90° suelo/techo <i>Connector floor/ ceiling angle 90°</i>	■	39,38 €	33,48 €	57,88 €
 CGPV/TPV	Punto de giro/ tejuelo vitrina <i>Top pin/ showcase</i>	■	9,45 €	8,25 €	13,88 €
 CPM	Cerrojillo + cerradero presión V10 <i>Locking bolt + strike box pressure V10</i>	■	56,64 €	46,48 €	83,26 €
 CPMF	Cerrojillo + cerradero presión V10 <i>Locking bolt + strike box pressure V10</i>	■	68,79 €	57,53 €	101,12 €
 GBPC	Guía baja puerta corredera <i>Floor guide for sliding door</i>	■	■	12,14 €	■
 PM	Cerrojillo presión V10 <i>Locking bolt pressure V10</i>	■	36,75 €	31,78 €	54,02 €
 PMF	Cerrojillo presión V10 <i>Locking bolt pressure V10</i>	■	37,11 €	32,79 €	54,56 €
 PV6	Pernio vitrina vidrio 6mm <i>Patch for showcase glass 6mm</i>	■	41,03 €	34,86 €	60,31 €
 PV8	Pernio vitrina vidrio 8mm <i>Patch for showcase glass 8mm</i>	■	39,65 €	33,48 €	58,29 €
 PV10	Pernio vitrina vidrio 10mm <i>Patch for showcase glass 10mm</i>	■	44,19 €	38,03 €	64,96 €
 S1LAA	Unión una luna <i>Connector</i>	■	15,21 €	11,08 €	22,35 €
 S1LAAS	Unión una luna suelo/techo <i>Connector floor/ceiling</i>	■	23,14 €	19,27 €	34,02 €
 S1LAC	Unión una luna <i>Connector</i>	■	25,98 €	20,11 €	38,19 €
 S1LBBE	Unión una luna taladros anclaje en aleta exterior <i>Connector with outside drilled plate</i>	■	18,65 €	14,86 €	27,41 €
 S1LBC	Unión una luna <i>Connector</i>	■	23,43 €	19,63 €	34,45 €
 S1LBD	Unión una luna vértices <i>Connector vertex</i>	■	30,46 €	26,65 €	44,77 €
 S1LEE	Unión una luna taladros anclaje en aleta exterior <i>Connector with outside drilled plate</i>	■	20,84 €	17,04 €	30,63 €





T

HERRAJES Y ACCESORIOS
FITTINGS AND ACCESSORIES

Ref.	Descripción / Description	CB	IB	IS	BL/NE
 S1LT	Unión luna techillo <i>Top pivot pin</i>	■	30,63 €	25,46 €	45,02 €
 SLT	Unión dos lunas techillo <i>Top pivot pin glass/ glass</i>	■	33,15 €	27,79 €	48,73 €
 SL90°T	Unión luna 90° techillo <i>Connector top pin 90°</i>	■	42,11 €	37,34 €	61,90 €
 SR	Soporte rótulos <i>Support</i>	12,74 €	■	■	18,73 €
 TP1	Tope presión simple V10 <i>Stopper pressure V10</i>	■	12,70 €	10,46 €	18,68 €
 TP2	Tope presión doble V10 <i>Double stopper pressure V10</i>	■	15,60 €	12,47 €	22,93 €
 TP3	Tope marco <i>Frame stopper</i>	■	9,42 €	8,35 €	13,84 €
 VA180	Habla escucha vidrio 10mm <i>Hearing window accessory for glass 10mm</i>	104,98 €	■	■	154,32 €
 VA212	Habla escucha vidrio 12mm <i>Hearing window accessory for glass 12mm</i>	123,48 €	■	■	181,52 €
 VA218	Habla escucha vidrio 18mm <i>Hearing window accessory for glass 18mm</i>	141,60 €	■	■	208,15 €
 VA224	Habla escucha vidrio 24mm <i>Hearing window accessory for glass 24mm</i>	143,01 €	■	■	210,22 €
 VA2540	Habla escucha telescópica para vidrio de 25 a 40mm <i>Telescopic hearing window, glass from 25 to 40mm</i>	256,80 €	■	■	377,49 €

TV12

HERRAJES Y ACCESORIOS. Vidrio 12mm
FITTINGS AND ACCESSORIES. 12mm glass

Ref.	Descripción / Description	IB	IS	BL/NE
 CPMV12	Cerrojillo + cerradero presión V12 <i>Locking bolt + strike box pressure</i>	73,15 €	62,99 €	99,37 €
 PMV12	Cerrojillo presión V12 <i>Locking bolt pressure</i>	50,21 €	45,62 €	67,48 €
 TP1V12	Tope presión simple V12 <i>Stopper pressure V12</i>	15,24 €	13,00 €	21,25 €
 TP2V12	Tope presión doble V12 <i>Double stopper pressure V12</i>	19,09 €	14,01 €	25,11 €

9000 FLAT





HERRAJES PARA GRANDES DIMENSIONES
FITTINGS FOR BIG DIMENSIONS

ESPECIFICAR EN EL PEDIDO EL ESPESOR DEL VIDRIO Y EL GIRO DESEADO (54mm - 106mm - 158mm)
SPECIFY IN ORDER THE GLASS THICKNESS AND THE DESIRED PIVOT ROTATION (54mm - 106mm - 158mm)

Ref.	Descripción / Description	IB	IS	BL/NE
 9000	Punto de giro superior <i>Top pivot</i>	10,36 €	10,08 €	15,22 €
9001 FLAT	Pernio alto para vidrio de 10/11/12mm <i>Top patch for glass thickness 10/11/12mm</i>	122,17 €	108,11 €	179,59 €
	Pernio alto para vidrio de 13/14/15mm <i>Top patch for glass thickness 13/14/15mm</i>	128,79 €	115,21 €	189,33 €
	Pernio alto para vidrio de 16/17/18mm <i>Top patch for glass thickness 16/17/18mm</i>	128,79 €	115,21 €	189,33 €
	Pernio alto para vidrio de 19/20/22mm <i>Top patch for glass thickness 19/20/22mm</i>	130,45 €	116,86 €	191,75 €
9002 FLAT	Pernio bajo regleta para vidrio de 10/11mm <i>Bottom patch for glass thickness 10/11mm</i>	112,82 €	103,42 €	165,86 €
	Pernio bajo regleta para vidrio de 12/13mm <i>Bottom patch for glass thickness 12/13mm</i>	124,38 €	110,51 €	182,83 €
	Pernio bajo regleta para vidrio de 14/15/16mm <i>Bottom patch for glass thickness 14/15/16mm</i>	124,38 €	110,51 €	182,83 €
	Pernio bajo regleta para vidrio de 18/19/20mm <i>Bottom patch for glass thickness 18/19/20mm</i>	126,02 €	112,16 €	185,24 €
	Pernio bajo regleta para vidrio de 22mm <i>Bottom patch for glass thickness 22mm</i>	126,02 €	112,16 €	185,24 €
9003 FLAT	Punto de giro montante para vidrio de 10/11/12mm <i>Overpanel patch glass thickness 10/11/12mm</i>	122,34 €	113,80 €	179,84 €
	Punto de giro montante para vidrio de 13/14/15mm <i>Overpanel patch for glass thickness 13/14/15mm</i>	133,89 €	116,45 €	196,83 €
	Punto de giro montante para vidrio de 16/17/18mm <i>Overpanel patch for glass thickness 16/17/18mm</i>	133,91 €	116,45 €	196,84 €
	Punto de giro montante para vidrio de 19/20/22mm <i>Overpanel patch for glass thickness 19/20/22mm</i>	135,56 €	118,09 €	199,28 €
9004 FLAT	Punto de giro lateral montante para V. 10/11/12mm <i>Overpanel & side panel patch for 10/11/12mm</i>	171,94 €	154,55 €	252,74 €
	Punto de giro lateral montante para V. 13/14/15mm <i>Overpanel & side panel patch for 13/14/15mm</i>	187,89 €	163,11 €	276,20 €
	Punto de giro lateral montante para V. 16/17/18mm <i>Overpanel & side panel patch for 16/17/18mm</i>	187,89 €	163,11 €	276,20 €
	Punto de giro lateral montante para V. 19/20/22mm <i>Overpanel & side panel patch for 19/20/22mm</i>	189,53 €	164,77 €	278,61 €

9000 FLAT

HERRAJES PARA GRANDES DIMENSIONES
FITTINGS FOR BIG DIMENSIONS

Ref.	Descripción / Description	IB	IS	BL/NE
	9005 FLAT Unión tres lunas para vidrio de 10/11/12/13mm <i>Connector for glass thickness 10/11/12/13mm</i>	109,97 €	97,93 €	161,65 €
	Unión tres lunas para vidrio de 14/15/16mm <i>Connector for glass thickness 14/15/16mm</i>	121,55 €	105,03 €	178,68 €
	Unión tres lunas para vidrio de 18/19/20/22mm <i>Connector for glass thickness 18/19/20/22mm</i>	123,19 €	106,67 €	181,09 €
	9006 FLAT Pernio bajo Cuadradillo 16/19 para vidrio de 10/11mm <i>Bottom patch square pivot 16/19 for glass thickness 10/11mm</i>	159,98 €	145,89 €	235,17 €
	Pernio bajo Cuadradillo 16/19 para vidrio de 12/13/14mm <i>Bottom patch square pivot 16/19 for glass 12/13/14mm</i>	171,52 €	153,00 €	252,14 €
	Pernio bajo Cuadradillo 16/19 para vidrio de 15/16/17mm <i>Bottom patch square pivot 16/19 for glass thickness 15/16/17mm</i>	171,52 €	153,00 €	252,14 €
	Pernio bajo Cuadradillo 16/19 para vidrio de 18/19/20/22mm <i>Bottom patch square pivot 16/19 for glass thickness 18/19/20/22mm</i>	173,36 €	154,80 €	254,84 €
	9007 FLAT Unión una luna para vidrio de 10/11/12/13mm <i>Connector for glass thickness 10/11/12/13mm</i>	62,02 €	50,43 €	91,17 €
	Unión una luna para vidrio de 14/15/16mm <i>Connector for glass thickness 14/15/16mm</i>	73,19 €	62,02 €	107,60 €
	Unión una luna para vidrio de 18/19/20/22mm <i>Connector for glass thickness 18/19/20/22mm</i>	75,98 €	64,81 €	111,69 €
	9008 FLAT Unión dos lunas para vidrio de 10/11/12/13mm <i>Connector for glass thickness 10/11/12/13mm</i>	86,74 €	75,95 €	114,23 €
	Unión dos lunas para vidrio de 14/15/16mm <i>Connector for glass thickness 14/15/16mm</i>	98,09 €	87,30 €	125,58 €
	Unión dos lunas para vidrio de 18/19/20/22mm <i>Connector for glass thickness 18/19/20/22mm</i>	101,90 €	91,12 €	129,39 €

WOOD







HERRAJES CARPINTERÍA
CARPENTRY HARDWARE

Ref.	Descripción / Description	CB	ZINCADO
 PACV	Alto vaivén escamoteable <i>Top patch for swinging glass doors</i>	■	40,76 €
 PBCV 13/16	Bajo vaivén cuadradillo 13/16 <i>Bottom patch pivot 13/16 for swinging glass doors</i>	■	17,80 €
 PBCV 16/19	Bajo vaivén cuadradillo 16/19 <i>Bottom patch pivot 16/19 for swinging glass doors</i>	■	17,80 €
 PACD	Alto desplazado <i>Top patch displaced</i>	43,53 €	■
 PBCD 13/16	Bajo desplazado cuadradillo 13/16 <i>Bottom patch pivot 13/16 displaced</i>	21,94 €	■
 PBCD 16/19	Bajo desplazado cuadradillo 16/19 <i>Bottom patch spindle 16/19 displaced</i>	21,94 €	■

6 PLINTOS / DOOR RAILS

ROBUST

PLINTOS DOOR RAILS

Ref.	Descripción / Description	IB	IS
 PLA	Alto para vidrio de 10 a 12mm, ancho hasta 1100mm Punto de giro escamoteable incorporado <i>Top door rail for 10/12mm glass, width until 1100mm</i> <i>Built-in pivot retractable point</i>	412,12 €	379,73 €
 PLAC	Alto con cerradura para vidrio de 10 a 12mm, ancho hasta 1100mm Punto de giro escamoteable incorporado <i>Top door rail+lock for 10/12mm glass, width until 1100mm</i> <i>Built-in pivot retractable point</i>	527,84 €	495,43 €
 PLB	Bajo para vidrio de 10 a 12mm, ancho hasta 1100mm Especificar regleta o cuadradillo C 16/19 <i>Bottom door rail for 10/12mm glass, width until 1100mm</i> <i>Specify strip or square C 16/19</i>	417,63 €	385,24 €
 PLBC	Bajo con cerradura para vidrio de 10 a 12mm, ancho hasta 1100mm Especificar regleta o cuadradillo C 16/19 <i>Bottom door rail+ lock for 10/12mm glass, width until 1100mm</i> <i>Specify strip or square C 16/19</i>	529,78 €	497,38 €
 PLL	Lateral fijo 90mm vidrio de 10 a 12mm, ancho hasta 1100mm <i>Side fix door rail for 10/12mm glass, width until 1100mm</i>	286,19 €	267,66 €
 T4750	Jgo. tirador plinto para puertas de altura hasta 2.500mm (consultar otras medidas) <i>Pair pull handle for door rail until lenght 2.500mm</i> <i>(for other lengths, please contact us)</i>	300,44 €	300,44 €



Para otros espesores de vidrio: Consultar / For other glass thickness: Contact Us



Para poder instalar el tirador en el plinto, éste debe ser solicitado junto con el pedido del mismo. Los tiradores sólo se pueden montar en los plintos que estén fabricados especialmente para ello, por lo cual el pedido del tirador y del plinto debe de ser simultáneo.

To install the pull handle in the door rail, it must be ordered with its own order. Pull handles can only be installed in the door rails which are manufactured specially for it, therefore, you must order the pull handle and the door rail simultaneously

7

ANTIPÁNICOS Y CRDA/CRDO ANTIPÁNICO
ANTIPANIC SYSTEM & ANTIPANIC LOCKS

BRAVE

ANTIPÁNICOS CON BARRA DE EMPUJE











ANTI-PANIC WITH PUSHING BAR

SUPLEMENTO VIDRIO 12mm
12mm GLASS SUPPLEMENT





8,02 €

SUPLEMENTO LLAVES IGUALES
IDENTICAL KEYS SUPPLEMENT





12,94 €

Ref.	Descripción / Description	IS	NE/IS
 18000	Cierre lateral con cerradero para marco <i>Lateral closing with strike box for frame</i>	999,08 €	569,80 €
 18001	Cierre lateral con cerradero para vidrio <i>Lateral closing with strike box glass/glass</i>	1.028,41 €	600,64 €
 18002	Cierre lateral con cerradero eléctrico para vidrio <i>Lateral closing with electric strike box for glass</i>	1.561,71 €	1.198,07 €
 18023	Manilla y llave exterior cierre lateral con cerradero para marco <i>Lateral closing with handle and key outside + strike box for frame</i>	1.222,81 €	692,66 €
 18024	Manilla y llave exterior con cierre lateral con cerradero para vidrio <i>Lateral closing with handle and key outside + strike box for glass</i>	1.261,14 €	733,39 €
 18025	Manilla y llave exterior cierre lateral con cerradero eléctrico a vidrio <i>Lateral closing handle and key outside + electric strike box glass</i>	1.638,28 €	1.216,72 €
 18300	Cierre alto para marco/techo y cierre bajo <i>Top closing wall/ceiling and bottom closing</i>	1.580,16 €	885,20 €
 18323	Manilla y llave exterior con cierre alto para marco/techo y cierre bajo <i>Handle and key outside top closing wall/ceiling and bottom closing</i>	1.858,08 €	1.001,14 €
 18301	Cierre alto con cerradero para montante de vidrio y cierre bajo <i>Overpanel top glass closing and bottom closing</i>	1.617,47 €	940,77 €
 18324	Manilla y llave exterior, cierre alto con crdo. para montante de vidrio y cierre bajo <i>Handle and key outside, overpanel patch closing and bottom closing</i>	1.895,40 €	1.056,71 €

Doble puerta en un mismo plano para instalar con marco o techo. Una puerta de función normal con cierre lateral y otra con cerradero lateral y cierre alto/bajo para dejar anclada y actuar de fijo, pudiéndose abrir siempre en caso de emergencia.
Double aligned door for installation to frame/ceiling. Glass door with lateral closing and another one with lateral strike box and top/bottom closing for fixing the glass door, but this fixed door can be opened in emergency case.

 18325	Cierre lateral con cerradero eléctrico en la puerta fija <i>Lateral closing with electrical strike box in fix glass door</i>	3.191,22 €	1.908,47 €
 18325/1	Manilla, llave exterior cierre lateral y cerradero eléctrico en puerta fija <i>Handle, key outside lateral closing, electrical strike box in fix glass</i>	3.368,79 €	2.067,29 €
 18325/2	Cierre lateral con cerradero en la puerta fija <i>Lateral closing with electrical strike box in fix glass door</i>	2.682,15 €	1.450,58 €
 18325/3	Manilla y llave exterior cierre lateral con cerradero en la puerta fija <i>Handle and key outside lateral closing with strike box in fix glass door</i>	2.875,43 €	1.573,97 €

Doble puerta en un mismo plano para instalar con montante de vidrio. Una puerta de función normal con cierre lateral y otra con cerradero lateral y cierre alto/bajo para dejar anclada y actuar de fijo, pudiéndose abrir siempre en caso de emergencia.
Double aligned door for installation to overpanel. Glass door with lateral closing and another one with lateral strike box and top/bottom closing for fixing the glass door, but this fixed door can be opened in emergency case.

 18326	Cierre lateral con cerradero eléctrico en la puerta fija <i>Lateral closing with electrical strike box in fix glass door</i>	3.129,76 €	2.116,83 €
 18326/1	Manilla, llave exterior cierre lateral y cerradero eléctrico en puerta fija <i>Handle, key outside lateral closing, electrical strike box in fix glass</i>	3.407,67 €	2.180,81 €
 18326/2	Cierre lateral con cerradero en la puerta fija <i>Lateral closing with electrical strike box in fix glass door</i>	2.720,65 €	1.487,88 €
 18326/3	Manilla y llave exterior cierre lateral con cerradero en la puerta fija <i>Handle and key outside lateral closing with strike box in fix glass door</i>	2.914,37 €	1.611,24 €
18413	Conjunto tubo + varilla superior altura puerta hasta 3 m. <i>Tube set + top rod for door height until 3 m.</i>	30,93 €	■

OPCIONES BAJO PEDIDO / OPTIONS UNDER REQUEST

* Suplemento vidrio 12mm 12mm glass supplement	11,69 €	Llaves iguales Identical keys	12,94 €	Cilindro llave 1 cara-condena 1 cara Key latch 1 side-latch funcion 1 side	17,75 €
--	----------------	---	----------------	--	----------------

* Otros espesores: CONSULTAR

* Other thickness: CONSULT

SAFE

CERRADURAS ANTIPÁNICO
ANTI-PANIC LOCKS



Ref.	Descripción / Description	IB	IS	BL/NE
15000	Pi/pa cilindro manilla int. Latch/lever, cylinder and inside handle	225,69 €	236,87 €	286,62 €
15001	Pi/pa cilindro manilla int. con tope Latch/lever, cylinder and inside handle with stopper	231,09 €	242,26 €	293,49 €
15002	Pi/pa cilindro manilla int. pomo fijo 002R ext. Latch/lever, cylinder, inside handle and outside fix knob 002R	230,43 €	252,36 €	292,65 €
15003	Pi/pa cilindro manilla int. con tope pomo fijo 002R ext. Latch/lever, cylinder, inside handle with stopper & outside fix knob 002R	235,84 €	257,75 €	299,51 €
15025	Pi/pa cilindro manilla int. anti-tarjeta Latch/lever, cylinder and inside anti card handle	222,38 €	233,57 €	282,42 €
15026	Pi/pa cilindro manilla int. anti-tarjeta y tope Latch/lever, cylinder and inside anti card handle with stopper	227,78 €	238,98 €	289,28 €
15027	Pi/pa cilindro manilla int. anti-tarjeta pomo fijo 002R ext. Latch/lever, cylinder, inside anti card handle and outside fix knob 002R	232,83 €	254,80 €	295,70 €
15028	Pi/pa cilindro manilla int. anti-tarjeta pomo fijo 002R ext. Tope Latch/lever, cylinder, anti card handle, outside fix knob/stopper 002R	256,35 €	260,20 €	325,58 €

* Sólo se pueden instalar con cerradero 15000, 15001, 15002 y 15003

* Only can be installed with strike box 15000, 15001, 15002 and 15003

SAFE MODULAR

CERRADURAS ANTIPÁNICO MODULARES
ANTI-PANIC MODULAR LOCKS



Ref.	Descripción / Description	IB/IS	BL/NE
M5000	Pi/pa cilindro 1/2 manilla interior Latch/lever, cylinder and 1/2 inside handle	198,22 €	251,74 €
M5001	Pi/pa cilindro 1/2 manilla interior con tope Latch/lever, cylinder, 1/2 inside handle with stopper	201,68 €	256,13 €
M5004	Pi/pa cilindro 1/2 manilla interior anti-tarjeta Latch/lever, cylinder, 1/2 inside handle and anti card system	201,09 €	255,38 €
M5005	Pi/pa cilindro 1/2 manilla interior con tope anti-tarjeta Latch/lever, cylinder, 1/2 inside handle with stopper and anti card system	204,55 €	259,77 €

* Sólo se pueden instalar con cerradero 15000, 15001, 15002 y 15003

* Only can be installed with strike box 15000, 15001, 15002 and 15003

SAFE

CERRADEROS ANTIPÁNICO
ANTI-PANIC STRIKE BOXES



Ref.	Descripción / Description	IB/IS	BL/NE
15050	Pi/pa vidrio <i>Latch/lever glass/glass</i>	86,00 €	109,22 €
15051	Pi/pa eléctrico vidrio 12V AC/DC con desbloqueo <i>Electric latch/lever glass/glass 12V AC/DC with unlocking system</i>	139,48 €	177,14 €
15075	Pi/pa carpintería <i>Latch/lever glass/wall</i>	19,65 €	24,96 €
15076	Pi/pa eléctrico carpintería 12V AC/DC con desbloqueo <i>Electric latch/lever glass/wall 12V AC/DC with unlocking system</i>	49,85 €	63,31 €









* Las referencias 15051 y 15076 solo podrán instalarse con las cerraduras 15000, 15001, 15002, 15003, M5000 y M5001

* The Items 15051 and 15076 only can be installed with locks 15000, 15001, 15002, 15003, M5000 and M5001

8 CERRADURAS COSMO / COSMO LOCKS

COSMO

CERRADURA MUESCA (AISI 316) Y MANILLA COLOR STANDARD LOCK WITH SLOT (AISI 316) & HANDLE IN STANDARD COLOR

Ref.	Descripción / Description	IB	IS
 COSMO 1000	Pi/pa cilindro Latch/lever, cylinder	90,44 €	86,80 €
 COSMO 1001	Pi/pa cilindro manillas Latch/lever, cylinder and handles	190,89 €	179,42 €
 COSMO 1003	Pi/pa cilindro manilla interior Latch/lever, cylinder and inside handle	139,57 €	133,37 €
 COSMO 1007	Pa cilindro Lever, cylinder	90,44 €	86,80 €
 COSMO 1009	Pi manillas Latch, cylinder	175,57 €	163,77 €
 COSMO 1011	Pi 1/2 cilindro exterior y manilla interior Latch, exterior cylinder and inside handle	152,29 €	146,44 €
 COSMO 1019	Pi cilindro Latch, cylinder	90,44 €	86,80 €
 COSMO 1021	Pi/pa condena y manillas Latch/lever, cylinder and handles	187,90 €	177,22 €

COLORES STANDARD / STANDARD COLORS



AN NE BR
AN NE SATIN



AN RED BR
AN RED SATIN



AN IB
AN IS



AN ORO BR
AN ORO SATIN





AN BLUE BR
AN BLUE SATIN



AN GREEN BR
AN GREEN SATIN









ACCESORIOS / RECAMBIOS ACCESSORIES / SPARE PARTS

Descripción / Description	IB	IS
 Conjunto manillas + adaptador Handle set + adaptor	77,70 €	68,85 €
 Conjunto 1/2 manilla + adaptador 1/2 handle set + adaptor	38,56 €	34,14 €
 Manilla (sin adaptador) Handle without adaptor	34,14 €	34,14 €

9 CERRADURAS CRONO / CRONO LOCKS

CRONO



CERRADURA MUESCA (AISI 316) Y MANILLA COLOR STANDARD LOCK WITH SLOT (AISI 316) & HANDLE STANDARD COLOR

Ref.	Descripción / Description	IB	IS
 CRONO 1000	Pi/pa cilindro Latch/lever, cylinder	90,44 €	86,80 €
 CRONO 1001	Pi/pa cilindro manillas Latch/lever, cylinder and handles	191,34 €	180,08 €
 CRONO 1003	Pi/pa cilindro manilla interior Latch/lever, cylinder and inside handle	140,00 €	133,99 €
 CRONO 1007	Pa cilindro Lever, cylinder	90,44 €	86,80 €
 CRONO 1009	Pi manillas Latch, cylinder	176,04 €	164,44 €
 CRONO 1011	Pi 1/2 cilindro exterior y manilla interior Latch, exterior cylinder and inside handle	152,70 €	147,02 €
 CRONO 1019	Pi cilindro Latch, cylinder	90,44 €	86,80 €
 CRONO 1021	Pi/pa condena y manillas Latch/lever, cylinder and handles	188,32 €	177,82 €

COLORES STANDARD / STANDARD COLORS













ACCESORIOS / RECAMBIOS ACCESSORIES / SPARE PARTS

Descripción / Description	IB	IS
 Conjunto manillas + adaptador Handle set + adaptor	78,67 €	69,44 €
 Conjunto 1/2 manilla + adaptador 1/2 handle set + adaptor	38,77 €	34,43 €
 Manilla (sin adaptador) Handle without adaptor	34,14 €	34,14 €

10

CERRADURAS-CERRADEROS MIR / MIR LOCKS-STRIKE BOXES

MIR		CERRADURAS / CERRADEROS <i>LOCKS / STRIKE BOXES</i>		
Ref.	Descripción / Description		IB	IS
	1001MIR-COSMO 1001MIR-CRONO	Pi/pa cilindro manillas <i>Latch/lever cylinder and handles</i>	315,75 €	309,20 €
	1003MIR-COSMO 1003MIR-CRONO	Pi/pa cilindro manillas interior <i>Latch/lever cylinder and inside handles</i>	266,88 €	260,33 €
	1005MIR-COSMO 1005MIR-CRONO	Pi/pa cilindro manillas interior - pomo 002R fijo exterior <i>Latch/lever cylinder inside handles and outside fix knob 002R</i>	289,12 €	320,71 €
	1011MIR-CRONO 1011MIR-COSMO	Pi 1/2 cilindro ext. manilla interior <i>Latch 1/2 outside cylinder and inside handle</i>	327,26 €	283,73 €
	2001MIR GLASS	Cerradero Pi/pa <i>Latch/lever strike boxes</i>	204,25 €	200,60 €
	2002MIR GLASS	Cerradero Pi/pa tope <i>Latch/lever and stopper strike boxes</i>	213,99 €	207,99 €
	2004MIR GLASS	Cerradero Pi/pa tope 12V AC/DC con desbloqueo <i>Electric latch/lever 12V AC/DC with unlocking system and stopper</i>	248,70 €	245,04 €
	3001MIR WOOD	Cerradero Pi/pa <i>Latch/lever strike boxes</i>	61,58 €	56,34 €
	3002MIR WOOD	Cerradero Pi/pa tope <i>Latch/lever and stopper strike boxes</i>	68,37 €	63,87 €
	3004MIR WOOD	Cerradero Pi/pa tope 12V AC/DC con desbloqueo <i>Electric latch/lever 12V AC/DC with unlocking system and stopper</i>	95,17	90,67 €

11 CERRADURAS-CERRADEROS BASTET / BASTET LOCKS-STRIKE BOXES

BASTET

CERRADURAS / CERRADEROS LOCKS / STRIKE BOXES



Ref.	Descripción / Description	IB	IS
1001BASTET COSMO	Pi/pa cilindro manillas COSMO <i>Latch/lever cylinder and handles COSMO</i>	262,04 €	259,92 €
1001BASTET CRONO	Pi/pa cilindro manillas CRONO <i>Latch/lever cylinder and handles CRONO</i>	262,04 €	259,92 €
2001BASTET GLASS	Cerradero Pi/pa <i>Latch/lever strike boxes</i>	155,95 €	154,20 €
3001BASTET WOOD	Cerradero Pi/pa <i>Latch/lever strike boxes</i>	54,01 €	51,11 €

12 CIERRES-ELECTROMAGNETICOS / ELECTROMAGNETIC LOCKS

MILETO

CERRADURAS ELECTROMAGNETICAS ELECTROMAGNETIC LOCKS



Ref.	Descripción / Description	IS
MILETO VMMT23	Ventosa electromagnética marco/techo + fuente alimentación <i>Frame/Ceiling electromagnetic suction cup + power supply</i>	314,83 €
MILETO VMM23	Ventosa electromagnética montante + fuente alimentación <i>Upright electromagnetic suction cup + power supply</i>	324,38 €

MAGNET

CERRADURAS MAGNETICAS MAGNETIC LOCKS



Ref.	Descripción / Description	AN-IS	AN-NE
MAGNET GLASS COSMO	Cerradura magnética + Cerradero <i>Magnetic lock + Strike boxes</i>	265,81 €	265,81 €
MAGNET GLASS CRONO	Cerradura magnética + Cerradero <i>Magnetic lock + Strike boxes</i>	265,81 €	265,81 €
MAGNET WOOD COSMO	Cerradura magnética + Cerradero <i>Magnetic lock + Strike boxes</i>	153,62 €	153,62 €
MAGNET WOOD CRONO	Cerradura magnética + Cerradero <i>Magnetic lock + Strike boxes</i>	153,62 €	153,62 €

13 CERRADURAS MEIA / MEIA LOCKS













OPCIONES BAJO PEDIDO / OPTIONS UNDER REQUEST

*Suplemento vidrio 12mm 12mm glass supplement	10,51 €	Llaves iguales Identical keys	12,96 €	Cilindro llave 1 cara-condena 1 cara Key latch 1 side-latch funcion 1 side	17,26 €
(/T) Tope V10/12mm para crda con apertura hacia el exterior, para instalación con crdo sin eléctrico (/T) Lock V10/12mm stopper for installations with outside opening without electric strike box				IB/IS	6,78 €
(/TE) Tope V10/12mm para crda con apertura hacia el exterior, para instalación con crdo eléctrico (/TE) Lock V10/12mm stopper for installations with outside opening with electric strike box				IB/IS	13,53 €

* Otros espesores y acabados: CONSULTAR
* Other thickness and finishes: CONSULT















MEIA

CERRADURAS LOCKS

Ref.	Descripción / Description	IB	IS	BL/NE
 1000	Pi/pa cilindro Latch/lever cylinder	70,04 €	70,12 €	88,94 €
 1001	Pi/pa cilindro manillas Latch/lever cylinder and handles	117,59 €	135,57 €	149,34 €
 1002	Pi/pa cilindro pomos 001R Latch/lever cylinder and knobs 001R	116,72 €	134,15 €	148,23 €
 1003	Pi/pa cilindro manilla interior Latch/lever cylinder and inside handle	94,68 €	103,69 €	120,24 €
 1004	Pi/pa cilindro pomo 003R interior Latch/lever cylinder inside knobs 003R	95,13 €	103,92 €	120,82 €
 1005	Pi/pa cilindro manilla interior - pomo 002R fijo exterior Latch/lever cylinder inside handle and outside fix knob 002R	119,75 €	137,45 €	152,08 €
 1006	Pi/pa cilindro pomo 003R interior - pomo 002R fijo exterior Latch/lever cylinder inside knob 003R and outside fix knob 002R	120,22 €	137,66 €	152,67 €
 1007	Pa cilindro Lever and cylinder	70,04 €	70,12 €	88,94 €
 1008	Pa cilindro pomos fijos 002R Lever cylinder and fix knobs 002R	120,20 €	137,65 €	152,65 €
 1009	Pi manillas Latch and handles	103,56 €	121,53 €	131,52 €
 1010	Pi pomos 001R Latch and knobs 001R	102,69 €	120,11 €	130,41 €
 1011	Pi 1/2 cilindro ext. manilla interior Latch 1/2 outside cylinder and inside handle	110,34 €	119,36 €	140,13 €
 1012	Pi 1/2 cilindro ext. pomo 003R interior Latch 1/2 outside cylinder and inside knob 003R	110,78 €	119,56 €	140,69 €

MEIA

CERRADURAS
LOCKS

Ref.	Descripción / Description	IB	IS	BL/NE
 1017	Pi 1/2 cilindro exterior manilla interior - pomo 002R fijo exterior <i>Latch 1/2 outside cylinder, inside handle and outside fix knob 002R</i>	135,38 €	153,08 €	171,93 €
 1018	Pi 1/2 cilindro exterior pomo 003R interior - pomo 002R fijo exterior <i>Latch 1/2 outside cylinder inside knob 003R and outside fix knob 002R</i>	135,84 €	153,30 €	172,51 €
 1019	Pi cilindro <i>Latch and cylinder</i>	70,04 €	70,12 €	88,94 €
 1020	Pi cilindro pomos 002R fijos <i>Latch, cylinder and fix knobs 002R</i>	120,20 €	137,65 €	152,65 €
 1021	Pi/pa condena manillas <i>Latch/Lever cylinder and handles</i>	119,65 €	140,13 €	151,96 €
 1022	Pi/pa condena pomos 001R <i>Latch/Lever cylinder and handles knobs 001R</i>	118,73 €	138,72 €	150,78 €
 1102	Pi/pa cilindro pomos 014R <i>Latch/lever cylinder and knobs 014R</i>	118,25 €	135,68 €	150,18 €
 1104	Pi/pa cilindro pomo 016R interior <i>Latch/lever cylinder and inside knobs 016R</i>	97,24 €	106,01 €	123,48 €
 1106	Pi/pa cilindro pomo 016R interior - pomo 015R fijo exterior <i>Latch/lever, cylinder, inside knob 016R & outside fix knobs 015R</i>	122,75 €	140,19 €	155,88 €
 1108	Pa cilindro pomos 015R fijos <i>Lever cylinder and fix knobs 015R</i>	118,25 €	135,68 €	150,18 €
 1110	Pi pomos 014R <i>Latch knobs 014R</i>	104,20 €	121,64 €	132,34 €
 1112	Pi 1/2 cilindro exterior pomo 016R interior <i>Latch 1/2 outside cylinder and inside knobs 016R</i>	112,89 €	121,64 €	143,37 €
 1118	Pi 1/2 cilindro ext. pomo 016R interior - pomo 015R fijo ext. <i>Latch, outside 1/2 cylinder, knob 016R, outside fix knob 015R</i>	138,37 €	155,82 €	175,73 €
 1120	Pi cilindro pomos 015R fijos <i>Latch, cylinder and fix knobs 015R</i>	121,06 €	138,48 €	153,74 €
 1122	Pi/pa condena pomos 014R <i>Latch/Lever cylinder and handles knobs 014R</i>	120,26 €	140,23 €	152,72 €

MEIA ON/OFF

CERRADURAS ON/OFF CON INDICADOR DE USO
ON/OFF LOCKS WITH USAGE INDICATOR



Ref.	Descripción / Description	IB	IS	BL/NE
1038	PI/PA condena manillas ON/OFF <i>Latch/Lever cylinder and handles ON/OFF</i>	172,04 €	172,04 €	205,30 €
1038/1	PI/PA condena pomos 001R ON/OFF <i>Latch/Lever cylinder and knobs 001R ON/OFF</i>	171,99 €	171,99 €	205,30 €
1038/2	PI/PA condena pomos 014R ON/OFF <i>Latch/Lever cylinder and knobs 014R ON/OFF</i>	172,07 €	189,25 €	205,30 €
1039	PA condena ON/OFF <i>Lever cylinder ON/OFF</i>	161,04 €	161,04 €	194,20 €
1039/1	PA condena pomos fijos 002R ON/OFF <i>Lever cylinder with fix knobs 002R ON/OFF</i>	174,62 €	174,62 €	244,86 €
1039/2	PA condena pomos fijos 015R ON/OFF <i>Lever cylinder with fix knobs 015R ON/OFF</i>	175,62 €	192,41 €	208,87 €

MEIA MODULAR

CERRADURAS
LOCKS



Ref.	Descripción / Description	IB/IS	BL/NE
M1000	Pi/Pa cilindro manillas <i>Latch/lever cylinder and handles</i>	82,42 €	104,67 €
M1003	Pi/Pa cilindro 1/2 manilla <i>Latch/lever cylinder and 1/2 handle</i>	79,80 €	101,35 €
M1006	Pi manillas <i>Latch and handles</i>	67,95 €	86,29 €
M1009	Pi 1/2 cilindro 1/2 manilla <i>Latch 1/2 cylinder and 1/2 handle</i>	85,26 €	108,28 €
M1011	Pi condena y manillas <i>Latch and handles</i>	86,37 €	109,68 €

14 CERRADURAS ARES-TER / ARES-TER LOCKS

OPCIONES BAJO PEDIDO / OPTIONS UNDER REQUEST

*Suplemento vidrio 12mm 12mm glass supplement	8,02 €	Llaves iguales Identical keys	12,94 €	Cilindro llave 1 cara-condena 1 cara Key latch 1 side-latch funcion 1 side	17,25 €
(/T) Tope V10/12mm en mecanismo para crda con apertura hacia el exterior, para instalación con crdo sin eléctrico (/T) Lock V10/12mm stopper to install with outside opening without electric strike box					
(/TE) Tope V10/12mm en mecanismo para crda con apertura hacia el exterior, para instalación con crdo eléctrico (/TE) Lock V10/12mm stopper to install with outside opening with electric strike box					
(/SCU) Tope V10/12mm en la escuadra para crda con apertura hacia el exterior (/TE) Lock V10/12mm stopper for installations with outside opening					

* Otros espesores: CONSULTAR
* Other thickness: CONSULT

ARES

CERRADURAS PETACA CON MUESCA FLASK LOCKS WITH SLOT

Ref.	Descripción / Description	IB	IS	BL/NE
1200	Pi/pa cilindro Latch/lever and cylinder	158,08 €	158,27 €	200,76 €
1201	Pi/pa cilindro manillas Latch/lever, cylinder and handles	217,63 €	246,10 €	276,39 €
1202	Pi/pa cilindro pomos 001R Latch/lever, cylinder and knobs 001R	220,71 €	244,21 €	280,31 €
1203	Pi/pa cilindro y manilla en mecanismo Latch/lever, cylinder and handle in mechanism	191,12 €	203,34 €	242,72 €
1204	Pi/pa cilindro y pomo 003R en mecanismo Latch/lever, cylinder and knob 003R in mechanism	191,74 €	203,58 €	243,50 €
1205	Pi/pa cilindro,manilla en mecanismo y pomo fijo 002R en escuadra Latch/lever, cylinder, handle in mechanism and fix knob 002R in cover	224,75 €	248,62 €	285,44 €
1206	Pi/pa cilindro,pomo 003R en mecanismo y pomo fijo 002R en escuadra Latch/lever,cylinder,knob 003R in mechanism and fix knob 002R in cover	224,75 €	248,89 €	286,25 €
1207	Pa cilindro Lever and cylinder	158,08 €	158,27 €	200,76 €
1208	Pa cilindro pomos fijos 002R Lever, cylinder and fix knobs 002R	225,38 €	248,88 €	286,24 €
1209	Pi manillas Latch and handles	203,06 €	227,26 €	257,89 €
1210	Pi pomos 001R Latch and knobs 001R	201,85 €	225,34 €	256,34 €
1211	Gancho escamoteable cilindro Hook hidden for glass sliding door and cylinder	210,86 €	219,19 €	267,79 €
1212	Pa/vaivén cilindro Lever for swinging door and cylinder	207,55 €	215,86 €	263,59 €
1219	Pi cilindro Lever and cylinder	158,08 €	158,27 €	200,76 €
1220	Pi cilindro-pomos fijos 002R Latch, cylinder and fix knobs 002R	225,38 €	248,88 €	286,24 €
1302	Pi/pa cilindro pomos 014R Latch/lever, cylinder and knobs 014R	222,75 €	246,23 €	282,90 €

ARES

CERRADURAS PETACA CON MUESCA
FLASK LOCKS WITH SLOT

Ref.	Descripción / Description	IB	IS	BL/NE
1304	Pi/pa cilindro y pomo 016R en mecanismo <i>Latch/lever, cylinder and knobs 016R in mechanism</i>	194,57 €	206,42 €	247,10 €
1306	Pi/pa cilindro, pomo 016R en mecan./pomo 015R fijo escuadra <i>Latch/lever, cylinder, knob 016R in mechanism, fix knob 015R in cover</i>	228,79 €	252,27 €	290,57 €
1308	Pa cilindro y pomos 015R fijos <i>Lever, cylinder and fix 015R knobs</i>	226,50 €	250,00 €	287,66 €
1310	Pi pomos 014R <i>Latch and knobs 014R</i>	203,91 €	227,41 €	258,97 €
1320	Pi cilindro y pomos 015R fijos <i>Latch, cylinder and fix knobs 015R</i>	226,50 €	250,00 €	287,66 €

TER

CERRADURAS PETACA SIN MUESCA
FLASK LOCKS WITHOUT SLOT

Ref.	Descripción / Description	IB	IS	BL/NE
1023	Pi/pa condena y manilla en mecanismo <i>Latch/lever cylinder and handle in mechanism</i>	167,63 €	176,31 €	212,89 €
1024	Pi/pa condena y pomo 003R en mecanismo <i>Latch/lever cylinder and knob 003R in mechanism</i>	166,72 €	174,85 €	211,75 €
1027	Pi/pa 1/2 cilindro en mecanismo <i>Latch/lever and 1/2 cylinder in mechanism</i>	137,77 €	137,92 €	174,94 €
1028	Pi/pa 1/2 cilindro manilla en mecanismo <i>Latch/lever 1/2 cylinder and handle in mechanism</i>	163,14 €	172,57 €	207,18 €
1029	Pi/pa 1/2 cilindro pomo 003R en mecanismo <i>Latch/lever 1/2 cylinder and knob 003R in mechanism</i>	163,65 €	172,79 €	207,83 €
1031	Pi/pa 1/2 cilindro pomo fijo 002R en mecanismo <i>Latch/lever 1/2 cylinder and fix knob 002R in mechanism</i>	163,62 €	172,78 €	207,80 €
1033	Pi manilla en mecanismo <i>Latch and handle in mechanism</i>	132,51 €	141,93 €	168,30 €
1034	Pi pomo 003R en mecanismo <i>Latch and knob 003R in mechanism</i>	133,02 €	142,17 €	168,94 €
1035	Pa 1/2 cilindro en mecanismo <i>Lever and 1/2 cylinder in mechanism</i>	137,75 €	137,92 €	174,94 €
1036	Pi 1/2 cilindro en mecanismo <i>Latch and 1/2 cylinder in mechanism</i>	137,75 €	137,92 €	174,94 €
1045	Gancho escamoteable/cilindro <i>Hook for glass sliding door and cylinder</i>	164,60 €	173,77 €	209,04 €
1046	Pa/vaivén cilindro <i>Lever for swinging door and cylinder</i>	171,00 €	174,93 €	217,17 €



TER

CERRADURAS PETACA SIN MUESCA
FLASK LOCKS WITHOUT SLOT

Ref.	Descripción / Description	IB	IS	BL/NE
1124	Pi/pa condena y pomo 016R en mecanismo <i>Latch/lever cylinder and knob 016R in mechanism</i>	168,31 €	176,42 €	213,76 €
1129	Pi/pa 1/2 cilindro y pomo 016R en mecanismo <i>Latch/lever 1/2 cylinder and knob 016R in mechanism</i>	165,80 €	174,96 €	210,56 €
1131	Pi/pa 1/2 cilindro y pomo 016R fijo en mecanismo <i>Latch/lever 1/2 cylinder and knob 016R in mechanism</i>	163,62 €	172,78 €	207,80 €
1134	Pi pomo 016R en mecanismo <i>Latch and knob 016R in mechanism</i>	135,19 €	144,33 €	171,69 €

**ARES
MODULAR**

CERRADURAS PETACA CON MUESCA
FLASK LOCKS WITH SLOT



Ref.	Descripción / Description	IB/IS	BL/NE
M3000	Pi/Pa cilindro manillas <i>Latch/lever cylinder and handles</i>	165,15 €	209,75 €
M3003	Pi/pa cilindro 1/2 manilla en mecanismo <i>Latch/lever cylinder, 1/2 handle in mechanism</i>	161,28 €	204,82 €
M3006	Pi manillas <i>Latch and handles</i>	140,61 €	178,57 €
M3007	Pi 1/2 manilla en mecanismo <i>Latch and 1/2 handle in mechanism</i>	137,49 €	174,61 €
M3009	Pi 1/2 cilindro en mecanismo 1/2 manilla en la escuadra <i>Latch, 1/2 cylinder in mechanism, 1/2 handle in squad</i>	155,40 €	197,36 €
M3011	Pi condena en mecanismo y manillas <i>Latch cylinder in mechanism and handles</i>	159,26 €	202,27 €
M3013	Pi/pa cilindro 1/2 manilla en la escuadra <i>Latch/lever cylinder, 1/2 handle in squad</i>	161,28 €	204,82 €

**TER
MODULAR**

CERRADURAS PETACA SIN MUESCA
FLASK LOCKS WITHOUT SLOT



Ref.	Descripción / Description	IB/IS	BL/NE
M4001	Pi/pa 1/2 cilindro 1/2 manilla en mecanismo <i>Latch/lever, 1/2 cylinder and 1/2 handle in mechanism</i>	145,41 €	184,66 €
M4007	Pi 1/2 manilla en mecanismo <i>Latch and, 1/2 handle in mechanism</i>	114,73 €	145,70 €
M4011	Pi condena y 1/2 manilla en mecanismo <i>Latch cylinder and 1/2 handle in mechanism</i>	138,43 €	175,81 €

15 CERRADURAS SCONTO / SCONTO LOCKS

OPCIONES BAJO PEDIDO / OPTIONS UNDER REQUEST

* Suplemento vidrio 12mm 12mm glass supplement	8,02 €	Llaves iguales Identical keys	12,94 €	Cilindro llave 1 cara-condena 1 cara Key latch 1 side-latch funcion 1 side	47,86 €
---	---------------	----------------------------------	----------------	---	----------------

* Otros espesores: CONSULTAR

* Other thickness: CONSULT















SCONTO

CERRADURAS GALCE REBATE DEPTHS LOCKS

Ref.	Descripción / Description	IB	IS	BL/NE
1400	Pi/pa cilindro Latch/lever and cylinder	166,97 €	166,97 €	212,05 €
1400/1	Pi/pa cilindro manillas Latch/lever, cylinder and handles	217,43 €	236,46 €	276,13 €
1400/2	Pi/pa cilindro pomos 001R Latch/lever, cylinder and knobs 001R	216,45 €	234,95 €	274,89 €
1400/3	Pi/pa cilindro pomos 014R Latch/lever, cylinder and knobs 014R	218,06 €	236,57 €	276,94 €
1401/1	Pi/pa cilindro manilla interior Latch/lever, cylinder and inside handle	193,08 €	202,65 €	245,21 €
1401/2	Pi/pa cilindro pomo interior 003R Latch/lever, cylinder inside knob 003R	193,59 €	202,87 €	245,86 €
1401/3	Pi/pa cilindro pomo 016R interior Latch/lever, cylinder and inside knob 016R	195,82 €	205,13 €	248,69 €
1402/1	Pi/pa cilindro manilla interior-pomo fijo 002R exterior Latch/lever, cylinder, inside handle and outside fix knob 002R	219,66 €	238,46 €	278,97 €
1403/1	Pi/pa cilindro pomo 003R interior - pomo fijo 002R exterior Latch/lever, cylinder, inside knob 003R and outside fix knob 002R	220,14 €	238,70 €	279,59 €
1403/3	Pi/pa cilindro pomo 016R interior - pomo 015R fijo exterior Latch/lever, cylinder, inside knob 016R & outside fix knob 015R	222,83 €	241,34 €	283,00 €
1410	Pa cilindro Lever and cylinder	166,97 €	167,07 €	212,05 €
1410/1	Pa cilindro pomos fijos 002R Lever, cylinder and fix knobs 002R	220,13 €	238,69 €	279,56 €
1410/3	Pa cilindro pomos 015R fijos Lever, cylinder and fix knobs 015R	221,03 €	239,55 €	280,71 €
1415	Pi cilindro Latch and cylinder	166,97 €	167,07 €	212,05 €
1415/1	Pi cilindro manillas Latch, cylinder and handles	160,49 €	179,58 €	203,83 €







SCONTO

CERRADURAS GALCE
REBATE DEPTH LOCKS

Ref.	Descripción / Description	IB	IS	BL/NE
 1415/2	Pi 001R pomos <i>Latch and knobs 001R</i>	159,53 €	178,06 €	202,60 €
 1415/3	Pi pomos 014R <i>Latch and cylinder knobs 014R</i>	161,15 €	179,67 €	204,66 €
 1416/1	Pi 1/2 cilindro exterior/manilla interior <i>Latch, outside 1/2 cylinder/inside handle</i>	167,65 €	177,22 €	212,92 €
 1416/2	Pi 1/2 cilindro exterior/pomo 003R interior <i>Latch, outside 1/2 cylinder/inside knob 003R</i>	168,16 €	177,47 €	213,57 €
 1416/3	Pi 1/2 cilindro exterior/pomo 016R interior <i>Latch, outside 1/2 cylinder/inside knob 016R</i>	170,37 €	179,67 €	216,37 €
 1417/1	Pi 1/2 cilindro exterior/manilla interior/pomo 003R exterior <i>Latch, outside 1/2 cylinder knob/inside handle 003R</i>	194,22 €	213,03 €	246,66 €
 1417/2	Pi 1/2 cilindro exterior/manilla interior/manilla exterior <i>Latch, outside 1/2 cylinder and handle/inside handle</i>	196,15 €	215,24 €	249,12 €
 1418/1	Pi 1/2 cilindro interior/pomo 003R int/pomo 002R fijo exterior <i>Latch, inside 1/2 cylinder/knob 003R/outside fix knob 002R</i>	194,72 €	213,26 €	247,30 €
 1418/3	Pi 1/2 cilindro pomo 016R interior/pomo 015R exterior <i>Latch, inside 1/2 cylinder knob 016R/outside knob 015R</i>	197,41 €	215,92 €	250,70 €
 1419/1	Pi cilindro pomos 014R <i>Latch, cylinder and knobs 014R</i>	220,13 €	238,69 €	279,56 €
 1419/3	Pi cilindro pomos 014R <i>Latch, cylinder and knobs 014R</i>	221,03 €	239,55 €	280,71 €
 1425/1	Pi/pa condensa manillas <i>Latch/lever cylinder and handles</i>	185,92 €	212,17 €	236,11 €
 1425/2	Pi/pa condensa pomos 001R <i>Latch/lever cylinder and knobs 001R</i>	202,31 €	229,34 €	256,93 €
 1425/3	Pi/pa condensa pomos 014R <i>Latch/lever cylinder and knobs 014R</i>	195,25 €	221,22 €	247,97 €
 1426	Pa/vaiven cilindro <i>Swing door and cylinder</i>	190,51 €	190,51 €	241,94 €

**SCONTO
MODULAR**

CERRADURAS GALCE
REBATE DEPTH LOCKS

Ref.	Descripción / Description	IB/IS	BL/NE
 M2000	Pi/pa cilindro manillas <i>Latch/lever cylinder and handles</i>	161,48 €	205,07 €
 M2003	Pi/pa cilindro 1/2 manilla en mecanismo <i>Latch/lever cylinder and 1/2 handle in mechanism</i>	157,37 €	199,85 €
 M2006	Pi manillas <i>Latch and handles</i>	121,35 €	154,12 €
 M2007	Pi 1/2 manilla en tapa <i>Latch and 1/2 handle in cover</i>	117,26 €	148,92 €
 M2009	Pi 1/2 cilindro en mecanismo 1/2 manilla en tapa <i>Latch 1/2 cylinder in mechanism and 1/2 handle in cover</i>	137,85 €	175,07 €
 M2011	Pi condena en tapa y manillas <i>Latch function with WC thumbturn in cover and handles</i>	142,63 €	181,14 €

16

CERRADURAS INTERNO / INTERNO LOCKS





OPCIONES BAJO PEDIDO / OPTIONS UNDER REQUEST

*Suplemento vidrio 12mm / 12mm glass supplement **9,58 €**

*Otros espesores: CONSULTAR
*Other thickness: CONSULT

INTERNO



CERRADURAS PARA INTERIOR
LOCKS FOR INTERIOR

Ref.	Descripción / Description	IB	IS	BL/NE
 1600	Pi manilla condena <i>Latch function with WC thumbturn in cover and handles</i>	104,89 €	108,12 €	133,21 €
 1600/1	Pi manillas condena <i>Latch function with WC thumbturn and handles</i>	104,89 €	108,12 €	133,21 €
 1601	Pi manilla <i>Latch and 1/2 handle</i>	85,08 €	85,08 €	108,06 €
 1601/1	Pi manillas <i>Latch and handles</i>	85,08 €	85,08 €	108,06 €

INTERNO ON/OFF



CERRADURAS PARA INTERIOR ON/OFF CON INDICADOR DE USO
LOCKS FOR INTERIOR DOORS ON/OFF WITH USAGE INDICATOR



Ref.	Descripción / Description	IB	IS	BL/NE
 1600/2	Pi manillas 038R condena indicador ON/OFF Latch 038R function for WC thumbturn and handles with ON/OFF indicator	127,76 €	127,76 €	157,48 €
 1600/3	Pi manillas 039R condena indicador ON/OFF Latch 039R function for WC thumbturn and handles with ON/OFF indicator	127,76 €	127,76 €	157,48 €
 1600/4	Pi pomos 001R condena indicador ON/OFF Knob 001R function for WC thumbturn and handles with ON/OFF indicator	133,54 €	133,54 €	163,78 €

INTERNO MODULAR

CERRADURAS PARA INTERIOR
LOCKS FOR INTERIOR

Ref.	Descripción / Description	IB/IS	BL/NE
 M6000	Pi manillas Latch and handles	77,08 €	97,89 €
 M6001	Pi condena manillas Latch cylinder and handles	98,31 €	124,85 €

17 CERRADURAS INDIETRO / INDIETRO LOCKS



OPCIONES BAJO PEDIDO / OPTIONS UNDER REQUEST

* Suplemento vidrio 12mm 12mm glass supplement	10,49 €	Llaves iguales Identical keys	12,94€	Cilindro llave 1 cara-condena 1 cara Key latch 1 side-latch funcion 1 side	17,25 €
---	----------------	----------------------------------	---------------	---	----------------

* Otros espesores: CONSULTAR
* Other thickness: CONSULT

INDIETRO

CERRADURAS PUERTA VAIVÉN
LOCKS FOR SWINGING DOORS

Ref.	Descripción / Description	IB	IS	BL/NE
 1500	PB/Vaivén cilindro PB/Swing door and cylinder	134,94 €	135,04 €	171,37 €
 1500/2	PB/Vaivén cilindro pomos fijos 002R PB/Swing door, cylinder and fix knobs 002R	192,75 €	214,38 €	244,79 €
 1500/3	PB/Vaivén cilindro pomos 015R fijos PB/Swing door, cylinder and fix knobs 015R	194,63 €	216,26 €	247,18 €

18 CERRADURAS HOOK / HOOK LOCKS

OPCIONES BAJO PEDIDO / OPTIONS UNDER REQUEST

* Suplemento vidrio 12mm 12mm glass supplement	10,49 €	Claves iguales Identical keys	12,94 €	Cilindro llave 1 cara-condena 1 cara Key latch 1 side-latch funcion 1 side	17,25 €
---	----------------	----------------------------------	----------------	---	----------------

* Otros espesores: CONSULTAR
* Other thickness: CONSULT

HOOK

CERRADURAS PUERTA CORREDERA LOCKS FOR SLIDING DOORS

Ref.	Descripción / Description	IB	IS	BL/NE
1037	Gancho escamoteable/cilindro Hook and retractable/cylinder	92,99 €	93,07 €	118,10 €
1037/1	Gancho escamoteable/cilindro pomos fijos 002R Hook and retractable/cylinder fix knobs 002R	150,98 €	171,08 €	191,74 €
1037/2	Gancho escamoteable/cilindro 1/2 pomo fijo 002R Hook and retractable/cylinder 1/2 fix knob 002R	121,98 €	132,07 €	154,92 €
1037/3	Gancho escamoteable/cilindro pomos fijos 015R Hook and retractable/cylinder fix knobs 015R	151,90 €	172,06 €	192,92 €
1037/4	Gancho escamoteable/cilindro 1/2 pomo fijo 015R Hook and retractable/cylinder 1/2 fix knob 015R	122,44 €	132,56 €	155,49 €
1037/5	Gancho escamoteable/condena pomos fijos 002R Hook and retractable/latch fix knobs 002R	155,41 €	155,41 €	197,53 €
1037/6	Gancho escamoteable/condena 1/2 pomo fijos 002R Hook and retractable/latch fix 1/2 knob 002R	126,30 €	126,30 €	160,26 €
1037/7	Gancho escamoteable/condena pomos fijos 015R Hook and retractable/latch fix knobs 015R	156,21 €	156,21 €	197,97 €
1037/8	Gancho escamoteable/condena 1/2 pomo fijos 015R Hook and retractable/latch fix 1/2 knob 015R	126,73 €	126,73 €	160,58 €
1037/9	Gancho escamoteable/condena Hook and retractable/latch	108,31 €	108,31 €	137,69 €

19 CERRADURAS JANO / JANO LOCKS

JANO

CERRADURAS HORIZONTALES HORIZONTAL LOCKS

Ref.	Descripción / Description	IB/IS	BL/NE
1700	Pi cilindro Latch and cylinder	129,42 €	164,36 €
1701	Pi cilindro manillas Latch, cylinder and handles	155,63 €	197,65 €

JANO

CERRADURAS HORIZONTALES
HORIZONTAL LOCKS

Ref.	Descripción / Description	IB/IS	BL/NE
1702	Pi cilindro pomos 001R <i>Latch, cylinder and knobs 001R</i>	155,63 €	197,65 €
1703	Pi manillas <i>Latch and handles</i>	143,17 €	181,82 €
1704	Pi pomos 001R <i>Latch and knobs 001R</i>	143,17 €	181,82 €
1705	Pi cilindro SIN GALCE <i>Latch and cylinder</i>	133,63 €	169,71 €
1706	Pi cilindro manillas SIN GALCE <i>Latch, cylinder and handles</i>	162,98 €	206,99 €
1707	Pi cilindro pomos 001R SIN GALCE <i>Latch, cylinder and knobs 001R</i>	162,98 €	206,99 €
1708	Pi manillas SIN GALCE <i>Latch and handles</i>	148,90 €	189,11 €
1709	Pi pomos 001R SIN GALCE <i>Latch and knobs 001R</i>	148,90 €	189,11 €
1702/1	Pi cilindro pomos fijos 001R <i>Latch, cylinder and fixed knobs 001R</i>	160,10 €	202,03 €
1707/1	Pi cilindro pomos fijos 001R SIN GALCE <i>Latch, cylinder and fixed knobs 001R</i>	164,56 €	206,39 €

20

CERRADURAS TERRA / TERRA LOCKS

TERRA

CERRADURAS QUIPON
"PUT ON -TAKE OFF" LOCKS











LLAVES IGUALES MISMO PRECIO
SAME KEYS SAME PRICE

Ref.	Descripción / Description	IB	IS	BL/NE
1013	Suelo rectangular llave 3 puntos seguridad <i>Lock with rectangular pivot and 3 security points</i>	64,27 €	64,49 €	92,17 €
1013/1	Suelo rectangular llave 5 puntos seguridad <i>Lock with rectangular pivot and 5 security points</i>	80,62 €	80,80 €	108,53 €
1016	Doble central llave 3 puntos seguridad <i>Lock glass/glass with 3 security points</i>	76,94 €	77,16 €	104,80 €
1016/1	Doble central llave 5 puntos seguridad <i>Lock glass/glass with 5 security points</i>	93,28 €	93,47 €	121,19 €
1025	Suelo redondo llave 3 puntos seguridad <i>Lock with rounded pivot and 3 security points</i>	63,69 €	63,89 €	91,62 €
1025/1	Suelo redondo llave 5 puntos seguridad <i>Lock with rounded pivot and 5 security points</i>	80,02 €	80,21 €	107,92 €
1013F	Suelo rectangular fijación mediante taladro - llave 3 puntos seguridad <i>Lock with fasten by means of drill, 3 security points</i>	69,03 €	69,25 €	96,89 €
1013F/1	Suelo rectangular fijación mediante taladro - llave 5 puntos seguridad <i>Lock with fasten by means of drill, 5 security points</i>	85,38 €	85,55 €	120,47 €
1025F	Suelo redondo fijación mediante taladro - llave 3 puntos seguridad <i>Lock with fasten by means of drill, 3 security points</i>	68,44 €	68,66 €	96,29 €
1025F/1	Suelo redondo fijación mediante taladro - llave 5 puntos seguridad <i>Lock with fasten by means of drill, 5 security points</i>	84,79 €	84,96 €	112,68 €

TERRA V12

CERRADURAS Y CERRADEROS. Vidrio 12mm
LOCKS AND STRIKE BOXES. Glass 12mm

LLAVES IGUALES MISMO PRECIO
SAME KEYS SAME PRICE

Ref.	Descripción / Description	IB	IS	BL/NE
 1013V12	Suelo rectangular llave 3 puntos seguridad V12 <i>Lock with rectangular pivot and 3 security points V12</i>	69,79 €	70,00 €	97,69 €
 1013/1V12	Suelo rectangular llave 5 puntos seguridad V12 <i>Lock with rectangular pivot and 5 security points V12</i>	84,36 €	85,40 €	112,26 €
 1016V12	Doble central llave 3 puntos seguridad V12 <i>Lock glass/glass with 3 security points V12</i>	82,52 €	82,74 €	110,42 €
 1016/1V12	Doble central llave 5 puntos seguridad V12 <i>Lock glass/glass with 5 security points V12</i>	98,42 €	98,64 €	126,31 €
 1025V12	Suelo redondo llave 3 puntos seguridad V12 <i>Lock with rounded pivot, 3 security points V12</i>	69,33 €	69,57 €	97,22 €
 1025/1V12	Suelo redondo llave 5 puntos seguridad V12 <i>Lock with rounded pivot, 5 security points V12</i>	85,24 €	85,46 €	113,15 €
 1013FV12	Suelo rect. fijación mediante taladro - llave 3 puntos seguridad V12 <i>Lock with fasten by means of drill, 3 security points V12</i>	74,55 €	74,75 €	102,46 €
 1013/1FV12	Suelo rect. fijación mediante taladro - llave 5 puntos seguridad V12 <i>Lock with fasten by means of drill, 5 security points V12</i>	89,12 €	89,33 €	117,02 €
 1025FV12	Suelo redondo fijación mediante taladro - llave 3 puntos seguridad V12 <i>Lock with fasten by means of drill, 3 security points V12</i>	87,28 €	87,51 €	115,19 €
 1025/1FV12	Suelo redondo fijación mediante taladro - llave 5 puntos seguridad V12 <i>Lock with fasten by means of drill, 5 security points V12</i>	90,00 €	90,23 €	117,90 €

21

MODULAR MANILLAS / MODULAR HANDLES

MODULAR

MANILLAS INOXIDABLE
HANDLES IN STAINLESS STEEL

Ref.	Descripción / Description	IB	IS	BL/NE
 035R	Móviles <i>Mobile handles</i>	34,84 €	33,44 €	44,24 €
 035R2	Media - móvil <i>1/2 mobile handle</i>	19,76 €	18,83 €	25,10 €
 037R	Móviles <i>Mobile handles</i>	31,42 €	23,90 €	39,90 €
 037R2	Media - móvil <i>1/2 mobile handle</i>	17,67 €	14,08 €	22,44 €
 038R	Móviles <i>Mobile handles</i>	30,54 €	23,25 €	38,78 €
 038R2	Media - móvil <i>1/2 mobile handle</i>	17,47 €	13,91 €	22,19 €
 039R	Móviles <i>Mobile handles</i>	31,06 €	23,65 €	39,45 €
 039R2	Media - móvil <i>1/2 mobile handle</i>	17,47 €	13,91 €	22,19 €

22 CERRADEROS MEIA / MEIA STRIKE BOXES

OPCIONES BAJO PEDIDO / OPTIONS UNDER REQUEST

*Suplemento vidrio 12mm / 12mm glass supplement **7,80 €**

* Otros espesores: CONSULTAR / * Other thickness: CONSULT

MEIA

CERRADEROS STRIKE BOXES

Ref.	Descripción / Description	IB/IS	BL/NE
2001	Pi/pa - Pa/vaivén Latch/lever - Lever swing door	40,93 €	51,99 €
2002	Pi/pa - Pa/vaivén tope Latch/lever and stopper	44,66 €	56,72 €
2005	Pa Lever	40,93 €	51,99 €
2006	Pa tope Lever and stopper	44,66 €	56,72 €
2007	Pi Latch	40,93 €	51,99 €
2008	Pi tope Latch and stopper	44,66 €	56,72 €

MEIA

CERRADEROS ELÉCTRICOS ELECTRIC STRIKE BOXES

Ref.	Descripción / Description	IB/IS	BL/NE
2003	Pi/pa eléctrico 12V AC/DC con desbloqueo Electric latch/lever 12V AC/DC with unlocking system	79,51 €	100,98 €
2004	Pi/pa eléctrico tope 12V AC/DC con desbloqueo Electric latch/lever 12V AC/DC with unlocking system and stopper	83,24 €	105,70 €
2009	Pi eléctrico 12V AC/DC con desbloqueo Electric latch 12V AC/DC with unlocking system	79,51 €	100,98 €
2010	Pi eléctrico tope 12V AC/DC con desbloqueo Electric latch 12V AC/DC with unlocking system and stopper	83,24 €	105,70 €

INALTRONIC MEIA

CERRADEROS ELECTRÓNICOS ELECTRONIC STRIKE BOXES

Ref.	Descripción / Description	IB/IS	BL/NE
2050	Pi/Pa INALTRONIC con emisor telemando incorporado Latch/lever INALTRONIC wireless with issuing remote control included	468,61 €	595,14 €
2051	Pi/Pa tope INALTRONIC con emisor telemando incorporado Latch/lever INALTRONIC wireless with issuing remote control included	472,33 €	599,86 €
2052	Pi INALTRONIC con emisor telemando incorporado Latch INALTRONIC wireless with issuing remote control	468,61 €	595,14 €
2053	Pi tope INALTRONIC con emisor telemando incorporado Latch INALTRONIC wireless, stopper & issuing remote control included	472,33 €	599,86 €

MEIA MINI

CERRADEROS MINI
MINI STRIKE BOXES



Ref.	Descripción / Description	IB/IS	BL/NE
2034	Pi/pa - Pa/vaivén Latch/lever - Lever swing door	45,03 €	57,19 €
2035	Pa Lever	45,03 €	57,19 €
2036	Pi Latch	45,03 €	57,19 €
2037	Pi/pa - Pa/vaivén tope Latch/lever - Lever swing and stopper	49,13 €	62,40 €
2038	Pa tope Lever and stopper	49,13 €	62,40 €
2039	Pi tope Latch and stopper	49,13 €	62,40 €

23

CERRADEROS PETACA ARES/TER / ARES/TER STRIKE BOXES

OPCIONES BAJO PEDIDO / OPTIONS UNDER REQUEST

*Suplemento vidrio 12mm / 12mm glass supplement **8,02 €**

* Otros espesores: CONSULTAR / * Other thickness: CONSULT

ARES Y TER

CERRADEROS PETACA SIN MUESCA
FLASK STRIKE BOXES WITHOUT SLOT



Ref.	Descripción / Description	IB/IS	BL/NE
2013	Pa Lever	87,62 €	111,28 €
2014	Pa tope en la escuadra Lever and stopper on the square	100,65 €	127,83 €
2021	Pi Latch	87,62 €	111,28 €
2022	Pi/pa - Pa/vaivén Latch/lever - Lever swing door	87,62 €	111,28 €
2023	Pi tope en la escuadra Latch and stopper on the square	100,65 €	127,83 €
2024	Pi/pa - Pa/vaivén tope en la escuadra Latch/lever - Lever swing door and stopper on the square	100,65 €	127,83 €
2027	Pa con tope en el mecanismo Lever with stopper in mechanism	107,25 €	136,21 €
2028	Pi con tope en el mecanismo Latch with stopper in mechanism	107,25 €	136,21 €
2029	Pi/pa con tope en el mecanismo Latch/lever with stopper in mechanism	107,25 €	136,21 €
2033	Gancho Hook	94,01 €	119,40 €

ARES Y TER

CERRADEROS ELÉCTRICOS PETACA SIN MUESCA
FLASK ELECTRIC STRIKE BOXES WITHOUT SLOT

Ref.	Descripción / Description	IB/IS	BL/NE
2011	Pi/pa eléctrico 12V AC/DC con desbloqueo <i>Electric latch/lever 12V AC/DC with unlocking system</i>	102,49 €	130,17 €
2012	Pi/pa eléctrico tope en escuadra 12V AC/DC con desbloqueo <i>Electric latch/lever 12V AC/DC with unlocking system and stopper on square</i>	115,55 €	146,76 €
2015	Pi eléctrico 12V AC/DC con desbloqueo <i>Electric latch 12V AC/DC with unlocking system</i>	102,49 €	130,17 €
2016	Pi eléctrico tope en escuadra 12V AC/DC con desbloqueo <i>Electric latch 12V AC/DC with unlocking system and stopper on square</i>	115,55 €	146,76 €

**INALTRONIC
ARES Y TER**

CERRADEROS ELECTRÓNICOS PETACA SIN MUESCA
FLASK ELECTRONIC STRIKE BOXES WITHOUT SLOT

Ref.	Descripción / Description	IB/IS	BL/NE
2054	Pi/Pa INALTRONIC con emisor telemando incorporado <i>Latch/lever INALTRONIC wireless with issuing remote control included</i>	485,96 €	617,16 €
2055	Pi/Pa tope INALTRONIC con emisor telemando incorporado <i>Latch/lever INALTRONIC wireless with issuing remote control included</i>	487,83 €	619,55 €
2056	Pi INALTRONIC con emisor telemando incorporado <i>Latch INALTRONIC wireless with issuing remote control</i>	485,96 €	617,16 €
2057	Pi tope INALTRONIC con emisor telemando incorporado <i>Latch INALTRONIC wireless, stopper & issuing remote control included</i>	487,83 €	619,55 €

24

CERRADEROS SCONTO / SCONTO STRIKE BOXES

OPCIONES BAJO PEDIDO / OPTIONS UNDER REQUEST

*Suplemento vidrio 12mm / 12mm glass supplement **8,02 €**

* Otros espesores: CONSULTAR / * Other thickness: CONSULT

SCONTO

CERRADEROS INSTALACIONES 90°
STRIKE BOXES FOR 90° INSTALLATIONS

Ref.	Descripción / Description	IB/IS	BL/NE
2408	Pi/pa instalación 90° A PRESIÓN Y APERTURA A AMBOS LADOS <i>Latch/lever, installation to 90° by pressure and opening door at both sides</i>	94,81 €	120,42 €
2409	Pa instalación 90° A PRESIÓN Y APERTURA A AMBOS LADOS <i>Lever, installation to 90° by pressure and opening door at both sides</i>	94,81 €	120,42 €
2410	Pi instalación 90° A PRESIÓN Y APERTURA A AMBOS LADOS <i>Latch, installation to 90° by pressure and opening door at both sides</i>	94,81 €	120,42 €
2414	Gancho instalación 90° A PRESIÓN <i>Hook, installation to 90° by pressure</i>	94,81 €	120,42 €
2411	Pi/pa instalación 90° CON MUESCA Y APERTURA A AMBOS LADOS <i>Latch/lever, installation to 90° with cutting & opening door at both sides</i>	107,31 €	136,28 €
2412	Pi instalación 90° CON MUESCA Y APERTURA A AMBOS LADOS <i>Latch, installation to 90° with cutting and opening door at both sides</i>	107,31 €	136,28 €
2413	Pa instalación 90° CON MUESCA Y APERTURA A AMBOS LADOS <i>Lever, installation to 90° with cutting and opening door at both sides</i>	107,31 €	136,28 €
2415	Gancho instalación 90° CON MUESCA <i>Hook, installation to 90° with cutting</i>	107,31 €	136,28 €

25 CERRADEROS INTERNO / INTERNO STRIKE BOXES

OPCIONES BAJO PEDIDO / OPTIONS UNDER REQUEST

*Suplemento vidrio 12mm / 12mm glass supplement **6,88 €**

* Otros espesores: CONSULTAR / * Other thickness: CONSULT

INTERNO

CERRADEROS PARA INTERIOR STRIKE BOXES FOR INTERIOR



Ref.	Descripción / Description	IB/IS	BL/NE
2030	Pi Latch	59,40 €	75,44 €
2031	Pi tope Latch and stopper	63,39 €	80,50 €
3013	Pi carpintería Latch for carpentry	14,12 €	17,94 €
3014	Pi tope carpintería Latch for carpentry and stopper	15,60 €	19,80 €

26 CERRADEROS INDIETRO / INDIETRO STRIKE BOXES

INDIETRO

CERRADEROS PUERTA VAIVÉN STRIKE BOXES FOR SWINGING DOORS



Ref.	Descripción / Description	IS	BL/NE
3012	PA/Vaivén carpintería Carpentry swing door	9,25 €	19,51 €

27 CERRADEROS HOOK / HOOK STRIKE BOXES

OPCIONES BAJO PEDIDO / OPTIONS UNDER REQUEST

*Suplemento vidrio 12mm / 12mm glass supplement **6,88 €**

* Otros espesores: CONSULTAR / * Other thickness: CONSULT

HOOK

CERRADEROS PUERTA CORREDERA STRIKE BOXES FOR SLIDING DOORS



Ref.	Descripción / Description	IB/IS	BL/NE
2025	Gancho Hook glass/glass	54,84 €	69,65 €
3011	Gancho carpintería Hook glass/wall	8,67 €	11,01 €

28 CERRADEROS JANO / JANO STRIKE BOXES

JANO

CERRADEROS STRIKE BOXES

Ref.	Descripción / Description	IB/IS	BL/NE
1750	Pi vidrio para crda GALCE <i>Latch glass/glass for lock</i>	59,60 €	75,69 €
1751	Pi vidrio para crda SIN GALCE <i>Latch glass/glass for lock</i>	71,60 €	90,94 €
1760	Pi carpintería marco para crda GALCE <i>Carpentry latch glass/wall with rebate depth for lock</i>	5,96 €	7,57 €
1761	Pi carpintería tope marco liso para crda GALCE <i>Carpentry latch glass/wall for lock</i>	11,27 €	14,31 €
1762	Pi carpintería tope marco liso para crda SIN GALCE <i>Carpentry latch glass/wall with rebate depth for lock</i>	11,27 €	14,31 €
1763	Pi carpintería marco liso para crda SIN GALCE <i>Carpentry latch glass/wall for lock</i>	5,96 €	7,57 €

29 CERRADEROS TERRA / TERRA STRIKE BOXES

OPCIONES BAJO PEDIDO / OPTIONS UNDER REQUEST

*Suplemento vidrio 12mm / 12mm glass supplement **5,40 €**

* Otros espesores: CONSULTAR / * Other thickness: CONSULT

TERRA

CERRADEROS QUIPON "TAKE OFF - PUT ON" STRIKE BOXES

Ref.	Descripción / Description	CB	IB/IS	BL/NE
2017	Rectangular vidrio <i>Rectangular glass/glass</i>	■	41,59 €	56,20 €
2019	Redondo vidrio <i>Round glass/glass</i>	■	43,12 €	57,61 €
4001	Rectangular para empotrar en suelo <i>Rectangular glass/floor for recessing</i>	15,78 €	■	26,48 €
4002	Doble rectangular para empotrar en suelo <i>Double glass/floor for recessing</i>	20,90 €	■	32,19 €
4003	Redondo para empotrar en suelo <i>Round glass/floor for recessing</i>	9,45 €	■	■

30

CERRADEROS WOOD / WOOD STRIKE BOXES

OPCIONES BAJO PEDIDO / OPTIONS UNDER REQUEST

* **Suplemento vidrio 12mm / 12mm glass supplement** **4,65 €**

* Otros espesores: **CONSULTAR** / * Other thickness: **CONSULT**

WOOD

CERRADEROS CARPINTERÍA
STRIKE BOXES FOR CARPENTRY

Ref.	Descripción / Description	IB/IS	BL/NE
3001	Pi/pa <i>Latch/lever</i>	6,97 €	10,76 €
3002	Pi/pa tope <i>Latch/lever and stopper</i>	12,30 €	16,17 €
3005	Pa <i>Lever</i>	6,97 €	10,76 €
3006	Pa tope <i>Lever and stopper</i>	12,30 €	16,17 €
3007	Pi <i>Latch</i>	6,97 €	10,76 €
3008	Pi tope <i>Latch and stopper</i>	12,30 €	16,17 €

WOOD

CERRADEROS ELÉCTRICOS CARPINTERÍA
ELECTRIC STRIKE BOXES FOR CARPENTRY

Ref.	Descripción / Description	IB/IS	BL/NE
3003	Pi/pa eléctrico 12V AC/DC con desbloqueo <i>Electric latch/lever 12V AC/DC with unlocking system</i>	334,70 €	338,58 €
3003/1	Pi/pa eléctrico 12V AC/DC con desbloqueo y memoria <i>Electric latch/lever 12V AC/DC with unlocking system and memory</i>	35,05 €	38,92 €
3003/4	Pi/pa eléctrico 12V DC funcionamiento invertido <i>Electric latch/lever 12V DC reversed functioning</i>	64,59 €	68,45 €
3004	Pi/pa eléctrico tope 12V AC/DC con desbloqueo <i>Electric latch/lever 12V AC/DC with unlocking system and stopper</i>	39,66 €	43,53 €
3004/1	Pi/pa eléctrico tope 12V AC/DC con desbloqueo y memoria <i>Electric latch/lever 12V AC/DC with unlocking system, memory and stopper</i>	40,00 €	43,87 €
3004/4	Pi/pa eléctrico tope 12V DC funcionamiento invertido <i>Electric latch/lever 12V DC with reversed functioning and stopper</i>	69,49 €	73,34 €
3009	Pi eléctrico 12V AC/DC con desbloqueo <i>Electric latch 12V AC/DC with unlocking system</i>	34,70 €	38,58 €
3009/1	Pi eléctrico 12V AC/DC con desbloqueo y memoria <i>Electric latch 12V AC/DC with unlocking system and memory</i>	35,05 €	38,92 €
3009/4	Pi eléctrico 12V DC funcionamiento invertido <i>Electric latch 12V DC with reversed functioning</i>	64,59 €	68,45 €

WOOD

CERRADEROS ELÉCTRICOS CARPINTERÍA

ELECTRIC STRIKE BOXES FOR CARPENTRY



Ref.	Descripción / Description	IB/IS	BL/NE
3010	Pi eléctrico tope 12V AC/DC con desbloqueo <i>Electric latch 12V AC/DC with unlocking system and stopper</i>	39,66 €	43,53 €
3010/1	Pi eléctrico tope 12V AC/DC con desbloqueo y memoria <i>Electric latch 12V AC/DC with unlocking system, memory and stopper</i>	40,00 €	43,87 €
3010/4	Pi eléctrico tope 12V DC funcionamiento invertido <i>Electric latch 12V DC with reversed functioning and stopper</i>	69,49 €	73,34 €

31

CERRADEROS ARTICULATUS / ARTICULATUS STRIKE BOXES

ARTICULATUS

CERRADEROS ELÉCTRICOS ARTICULADOS

ELECTRIC ARTICULATED STRIKE BOXES



Ref.	Descripción / Description	IB
004C	Cjto cerradero articulado funcionamiento invertido 12V AC/DC memoria <i>Set articulated strike box, reversed functioning, 12V AC/DC memory</i>	411,95 €
019C	Cjto cerradero articulado funcionamiento invertido 12V AC/DC memoria, empotrar <i>Set articulated strike box, reversed functioning, 12V AC/DC memory for recessing</i>	354,55 €
021C	Cerradero articulado funcionamiento invertido 12V DC memoria <i>Articulated strike box, reversed functioning, 12V DC memory</i>	281,01 €
005C	Cerradero articulado funcionamiento invertido 12V DC memoria, empotrar <i>Articulated strike box, reversed functioning, 12V DC memory for recessing</i>	222,58 €



Exclusivamente para vidrios de 10 mm de espesor
Exclusively for 10mm glass thicknesses

32

CUBRECABLES CELTA / CELTA CABLE COVER

CELTA

CUBRECABLES

CABLE COVER









Ref.	Descripción / Description	IB
5100	Cubre cables 1000mm <i>Cable cover 1000mm</i>	97,28 €
6100	Cubre cables canto tiras de 1000mm <i>Cable cover 1000mm</i>	23,81 €

33 CONTROLES DE ACCESO/ ACCESS CONTROL

ACCES

CONTROLES DE ACCESO

ACCESS CONTROL

Ref.	Descripción / Description	PVP
 K16	Control de acceso teclado numérico y lector de tarjetas para exterior 12/24 Vdc <i>Access control by numerical keyboard and card reader for exterior use 12/24 Vdc</i>	337,96 €
 K17	Control de acceso función huella dactilar y lector de tarjetas para exterior 12/24 Vdc <i>Access control by fingerprint and card reader for exterior use 12/24 Vdc</i>	401,73 €
 K18	Control de acceso reconocimiento facial y lector de tarjetas 12 Vdc <i>Access control by facial recognition and card reader function 12 Vdc</i>	707,81 €
 K19	Control de acceso Inalámbrico tarjeta/teclado <i>Wireless access control by card / keyboard</i>	372,40 €
 K21	Control de acceso WIFI con teclado / tarjeta / huella dactilar para exterior - se suministra sin fuente de alimentación. <i>WiFi access control by numerical keyboard /card / fingerprint reader for external use.</i>	337,96 €
Ref.	Descripción / Description	PVP
 K33	Tarjeta para lector por proximidad (Pack de 5u) <i>Card for proximity reader (Kit of 5pcs)</i>	9,65 €
 001C	Fuente alimentación 220V/12V DC estabilizada 0,5 AMP <i>Power supply 220V/12V DC established 0,5 AMP</i>	114,32 €
 003C	Receptor invertido FM <i>Reversed receiver FM</i>	295,67 €
 006C	Emisor telemando FM <i>Issuing remote FM</i>	58,75 €
 017C	Transformador 220V/12V AC 0,5 AMP <i>Transformer 220V/12V AC 0,5 AMP</i>	27,91 €
 018C	Transformador/receptor FM 220V/12V AC 0,5 AMP <i>Transformer/ receiver 220V/12V AC 0,5 AMP</i>	295,70 €

MEIA ENIQ APP

CONTROLES DE ACCESO
ACCESS CONTROL



Ref.	Descripción / Description	A ambos lados At both sides IS	1 lado 1 side IS	1/2 cil.ENIQ 1/2 Cyl.ENIQ IS
1000DE	Crda. MEIA Pi/Pa + cilindro ENIQ APP Lock Latch/Lever + cylinder ENIQ APP	1.292,49 €	979,75 €	■
1007DE	Crda. MEIA Pa + cilindro ENIQ APP Lock Lever + cylinder ENIQ APP	1.292,49 €	979,75 €	■
1019DE	Crda. MEIA Pi + cilindro ENIQ APP Lock Latch + cylinder ENIQ APP	1.292,49 €	979,75 €	■
1011DE	Crda. MEIA Pi + 1/2 cilindro ENIQ APP + manilla Lock MEIA Latch + 1/2 cylinder ENIQ APP+ handle	■	■	965,46 €
1012DE	Crda. MEIA Pi + 1/2 cilindro ENIQ APP + pomo 003R Lock MEIA Latch + 1/2 cylinder ENIQ APP+ knob 003R	■	■	965,81 €

ACCESORIOS NECESARIOS NO INCLUIDOS
NECESSARY ACCESSORIES NOT INCLUDED

Descripción / Description	PVP
Tarjeta Master ENiQ ENiQ Master card	26,17 €
Kit de puesta en marcha: tarjeta master + herramientas para cilindro PRO Start-up kit: master card + tools for PRO cylinder	97,07 €
Tarjeta Master Open APP: Licencia sin límites para más de 5 dispositivos por sistema Open APP Master Card: Unlimited license for more than 5 devices per system	291,77 €
TAG Mifare Desfire EV3 8K TAG Mifare Desfire EV3 8K	11,51 €

MEIA TAPKEY

CONTROLES DE ACCESO
ACCESS CONTROL



Ref.	Descripción / Description	A ambos lados At both sides IS	1 lado 1 side IS	1/2 cilindro 1/2 Cylinder IS
1000DT	Crda. MEIA Pi/Pa + cilindro TAPKEY Lock Latch/Lever + cylinder TAPKEY	1.333,27 €	954,32 €	■
1007DT	Crda. MEIA Pa + cilindro TAPKEY Lock Lever + cylinder TAPKEY	1.333,27 €	954,32 €	■
1019DT	Crda. MEIA Pi + cilindro TAPKEY Lock Latch + cylinder TAPKEY	1.333,27 €	954,32 €	■
1011DT	Crda. MEIA Pi + 1/2 cilindro TAPKEY + manilla Lock MEIA Latch + 1/2 cylinder TAPKEY + handle	■	■	979,75 €
1012DT	Crda. MEIA Pi + 1/2 cilindro TAPKEY + pomo Lock MEIA Latch + 1/2 cylinder TAPKEY + knob	■	■	979,75 €

ACCESORIOS INCLUIDOS / INCLUDED ACCESSORIES

Cilindro TAPKEY+tarjeta owner con 5 licencias+herramientas
TAPKEY cylinder + owner card with 5 licenses + tools

34

JUNTAS DE ESTANQUEIDAD/ PERFILERÍA INOXIDABLE
GASKETS FOR SHOWER BOX/ INOX PROFILES



En color negro: CONSULTAR DISPONIBILIDAD
In black color: CONTACT US FOR AVAILABILITY

AQUA

JUNTAS DE ESTANQUEIDAD
GASKETS FOR SHOWER BOX





Ref.	Descripción / Description	
112C6	12 tiras labio central y vierte-aguas vidrio 6mm L-2.500mm <i>Set 12u drip flat seal for glass thickness 6mm L-2.500mm</i>	94,01 €
112C8	12 tiras labio central y vierte-aguas vidrio 8mm L-2.500mm <i>Set 12u drip flat seal for glass thickness 8mm L-2.500mm</i>	97,36 €
112C10	12 tiras labio central y vierte-aguas vidrio 10mm L-2.500mm <i>Set 12u drip flat seal for glass thickness 10mm L-2.500mm</i>	112,07 €
113C6	12 tiras labio lateral vidrio 6mm L-2.500mm <i>Set 12u drip flat seal for glass thickness 6mm L-2.500mm</i>	85,14 €
113C8	12 tiras labio lateral vidrio 8mm L-2.500mm <i>Set 12u drip flat seal for glass thickness 8mm L-2.500mm</i>	88,82 €
113C10	12 tiras labio lateral vidrio 10mm L-2.500mm <i>Set 12u drip flat seal for glass thickness 10mm L-2.500mm</i>	101,35 €
114C6	12 tiras burbuja vidrio 6mm L-2.500mm <i>Set 12u glass in wall ball seal for glass thickness 6mm L-2.500mm</i>	86,69 €
114C8	12 tiras burbuja vidrio 8mm L-2.500mm <i>Set 12u glass in wall ball seal for glass thickness 8mm L-2.500mm</i>	90,32 €
114C10	12 tiras burbuja vidrio 10mm L-2.500mm <i>Set 12u glass in wall ball seal for glass thickness 10mm L-2.500mm</i>	97,68 €
212C6	50 tiras labio central y vierte-aguas vidrio 6mm L-2.500mm <i>Set 50u drip flat seal for glass thickness 6mm L-2.500mm</i>	320,23 €
212C8	50 tiras labio central y vierte-aguas vidrio 8mm L-2.500mm <i>Set 50u drip flat seal for glass thickness 8mm L-2.500mm</i>	330,02 €
212C10	50 tiras labio central y vierte-aguas vidrio 10mm L-2.500mm <i>Set 50u drip flat seal for glass thickness 10mm L-2.500mm</i>	388,38 €
213C6	50 tiras labio lateral vidrio 6mm L-2.500mm <i>Set 50u drip flat seal for glass thickness 6mm L-2.500mm</i>	281,58 €
213C8	50 tiras labio lateral vidrio 8mm L-2.500mm <i>Set 50u drip flat seal for glass thickness 8mm L-2.500mm</i>	296,18 €
213C10	50 tiras labio lateral vidrio 10mm L-2.500mm <i>Set 50u drip flat seal for glass thickness 10mm L-2.500mm</i>	345,92 €
214C6	50 tiras burbuja vidrio 6mm L-2.500mm <i>Set 50u glass in wall ball seal for glass thickness 6mm L-2.500mm</i>	287,54 €
214C8	50 tiras burbuja vidrio 8mm L-2.500mm <i>Set 50u glass in wall ball seal for glass thickness 8mm L-2.500mm</i>	302,16 €
214C10	50 tiras burbuja vidrio 10mm L-2.500mm <i>Set 50u glass in wall ball seal for glass thickness 10mm L-2.500mm</i>	331,31 €
115C8/10NSN-SNS	12 tiras burbuja magnética 45° vidrio 8/10mm L-2.200mm <i>Set 12u glass in wall ball magnetic seal 45° for glass 8/10mm L-2.200mm</i>	288,69 €
315C8/10NSN-SNS	25 tiras burbuja magnética 45° vidrio 8/10mm L-2.200mm <i>Set 25u glass in wall ball magnetic seal 45° for glass 8/10mm L-2.200mm</i>	585,96 €
215C8/10NSN-SNS	50 tiras burbuja magnética 45° vidrio 8/10mm L-2.200mm <i>Set 50u glass in wall ball magnetic seal 45° for glass 8/10mm L-2.200mm</i>	1.157,63 €

AQUA

JUNTAS DE ESTANQUEIDAD
GASKETS FOR SHOWER BOX

Ref.

Descripción / Description

 115C6NS/SN	12 tiras burbuja magnética 45º vidrio 6mm L-2.200mm <i>Set 12u glass in wall ball magnetic seal 45º glass thickness 6mm L-2.200mm</i>	177,75 €
315C6NS/SN	25 tiras burbuja magnética 45º vidrio 6mm L-2.200mm <i>Set 25u glass in wall ball magnetic seal 45º glass thickness 6mm L-2.200mm</i>	354,86 €
215C6NS/SN	50 tiras burbuja magnética 45º vidrio 6mm L-2.200mm <i>Set 50u glass in wall ball magnetic seal 45º for glass 8/10mm L-2.200mm</i>	695,43 €
116C10NS	12 tiras burbuja magnética vidrio 10mm L-2.200mm <i>Set 12u glass in wall ball magnetic seal glass thickness 10mm L-2.200mm</i>	264,56 €
 316C10NS	25 tiras burbuja magnética vidrio 10mm L-2.200mm <i>Set 25u glass in wall ball magnetic seal glass thickness 10mm L-2.200mm</i>	515,72 €
216C10NS	50 tiras burbuja magnética vidrio 10mm L-2.200mm <i>Set 50u glass in wall ball magnetic seal glass thickness 10mm L-2.200mm</i>	1.016,98 €
116C6/8NS	12 tiras burbuja magnética vidrio 6/8mm L-2.200mm <i>Set 12u glass in wall ball magnetic seal glass thickness 6/8mm L-2.200mm</i>	177,75 €
316C6/8NS	25 tiras burbuja magnética vidrio 6/8mm L-2.200mm <i>Set 25u glass in wall ball magnetic seal glass thickness 6/8mm L-2.200mm</i>	354,86 €
216C6/8NS	50 tiras burbuja magnética vidrio 6/8mm L-2.200mm <i>Set 50u glass in wall ball magnetic seal glass thickness 6/8mm L-2.200mm</i>	695,43 €



PERIMETER

PERFILERÍA INOXIDABLE
INOX PROFILES

Ref.

Descripción / Description







IB

 12030C	12 tiras perfil "U" 25x15x25x1mm para techo vidrio 10mm L-2.500mm <i>Set 12u profile in "U" 25x15x25x1mm for ceilling for glass 10mm L-2.500mm</i>	407,39 €
12031C	12 tiras perfil "U" 15x15x15x1mm para suelo vidrio 10mm L-2.500mm <i>Set 12u profile in "U" 15x15x15x1mm for ceilling for glass 10mm L-2.500mm</i>	299,13 €
12032C	12 tiras perfil "U" 15x12x15x1mm para vidrio 8mm L-2.500mm <i>Set 12u profile in "U" 15x12x15x1mm for glass thickness 8mm L-2.500mm</i>	285,37 €
 12033C	12 tiras perfil "U" 15x10x15x1mm para vidrio 6mm L-2.500mm <i>Set 12u profile in "U" 15x10x15x1mm for glass thickness 6mm L-2.500mm</i>	281,62 €

35 TIRADORES / PULL HANDLES









CIRCUM

TIRADORES HANDLES

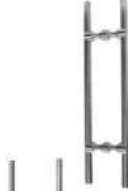
Ref.	Descripción / Description	IB	IS	BL/NE
 T4720	Juego tirador 200-350 Ø20 Handle set 200-350 Ø20	113,34 €	110,90 €	136,98 €
T4720	Juego tirador 250-400 Ø20 Handle set 250-400 Ø20	116,46 €	115,08 €	139,09 €
T4720	Juego tirador 300-450 Ø20 Handle set 300-450 Ø20	119,39 €	117,35 €	141,28 €
 T4725	Juego tirador 250-400 Ø25 Handle set 250-400 Ø25	120,89 €	119,63 €	143,55 €
T4725	Juego tirador 300-450 Ø25 Handle set 300-450 Ø25	125,59 €	123,34 €	145,97 €
T4725	Juego tirador 400-550 Ø25 Handle set 400-550 Ø25	127,89 €	126,28 €	148,20 €
 T4730	Juego tirador 200-400 Ø30 Handle set 200-400 Ø30	116,95 €	121,21 €	160,19 €
T4730	Juego tirador 250-500 Ø30 Handle set 250-500 Ø30	121,30 €	130,52 €	164,55 €
T4730	Juego tirador 300-600 Ø30 Handle set 300-600 Ø30	129,41 €	133,80 €	173,84 €
 T4730S	1/2 Tirador con soporte 200-400 Ø30 1/2 handle with support 200-400 Ø30	73,08 €	74,11 €	99,00 €
T4730S	1/2 Tirador con soporte 250-500 Ø30 1/2 handle with support 250-500 Ø30	80,89 €	78,71 €	106,80 €
T4730S	1/2 Tirador con soporte 300-600 Ø30 1/2 handle with support 300-500 Ø30	82,86 €	79,96 €	109,49 €
 T4730A	Agarradera 200-400 Ø30 Handle 200-400 Ø30	78,83 €	71,31 €	104,74 €
T4730A	Agarradera 250-500 Ø30 Handle 250-500 Ø30	80,92 €	75,93 €	106,88 €
T4730A	Agarradera 300-600 Ø30 Handle 300-600 Ø30	82,58 €	77,18 €	108,52 €
 T4758	Juego tirador 200-300 Ø40 Handle set 200-300 Ø40	130,63 €	122,76 €	175,78 €
T4758	Juego tirador 250-400 Ø40 Handle set 250-400 Ø40	133,86 €	126,63 €	178,29 €
T4758	Juego tirador 300-500 Ø40 Handle set 300-500 Ø40	137,19 €	130,67 €	182,14 €













CIRCUM

TIRADORES
HANDLES

Ref.	Descripción / Description	IB	IS	BL/NE
 T4758S	1/2 Tirador con soporte 200-300 Ø40 <i>1/2 handle with support 200-300 Ø40</i>	92,56 €	83,90 €	118,52 €
T4758S	1/2 Tirador con soporte 250-400 Ø40 <i>1/2 handle with support 250-400 Ø40</i>	94,15 €	85,85 €	121,27 €
T4758S	1/2 Tirador con soporte 300-500 Ø40 <i>1/2 handle with support 300-500 Ø40</i>	95,82 €	87,83 €	122,92 €
 T4758P	Tirador para pegar en vidrio 200-300 Ø40 <i>Handle with self adhesive fixing 200-300 Ø40</i>	112,03 €	101,47 €	156,44 €
T4758P	Tirador para pegar en vidrio 250-400 Ø40 <i>Handle with self adhesive fixing 250-400 Ø40</i>	113,64 €	103,40 €	158,56 €
T4758P	Tirador para pegar en vidrio 300-500 Ø40 <i>Handle with self adhesive fixing 300-500 Ø40</i>	115,31 €	105,61 €	159,45 €
 T4760	Juego tirador regulable 500 Ø20 <i>Adjustable handle set 500 Ø20</i>	234,37 €	220,69 €	■
T4761	Juego tirador regulable 400 Ø10 <i>Adjustable handle set 400 Ø10</i>	96,97 €	85,79 €	■
T4761	Juego tirador regulable 500 Ø10 <i>Adjustable handle set 500 Ø10</i>	99,46 €	87,43 €	■
T4761	Juego tirador regulable 600 Ø10 <i>Adjustable handle set 600 Ø10</i>	103,61 €	92,87 €	■
 T4761S	1/2 tirador regulable 400 Ø10 <i>1/2 adjustable handle 400 Ø10</i>	50,38 €	44,83 €	■
T4761S	1/2 tirador regulable 500 Ø10 <i>1/2 adjustable handle 500 Ø10</i>	52,51 €	46,92 €	■
T4761S	1/2 tirador regulable 600 Ø10 <i>1/2 adjustable handle 600 Ø10</i>	54,79 €	48,69 €	■
 T4765	Juego tirador regulable 1200 Ø30 <i>Adjustable handle 1200 Ø30 set</i>	250,44 €	239,01 €	■
T4767	Juego tirador regulable 1200 Ø20 <i>Adjustable handle 1200 Ø20 set</i>	192,65 €	166,99 €	■
 T4765S	1/2 tirador regulable 1200 Ø30 <i>1/2 adjustable handle 1200 Ø30</i>	132,89 €	126,59 €	■
T4767S	1/2 tirador regulable 1200 Ø20 <i>1/2 adjustable handle 1200 Ø20</i>	100,88 €	88,38 €	■
 T4769	Juego tirador roble 200 Ø40 <i>Oak handle set 200 Ø40</i>	116,53 €	114,96 €	■
T4769	Juego tirador roble 250 Ø40 <i>Oak handle set 250 Ø40</i>	118,58 €	116,87 €	■
 T4769	Juego tirador roble 300 Ø40 <i>Oak handle set 300 Ø40</i>	121,14 €	118,82 €	■

CIRCUM



TIRADORES
HANDLES

Ref.	Descripción / Description	IB	IS
 T4769S	1/2 tirador roble 200 Ø40 1/2 oak handle 200 Ø40	89,88 €	88,75 €
 T4769S	1/2 tirador roble 250 Ø40 1/2 oak handle 250 Ø40	95,55 €	89,49 €
 T4769S	1/2 tirador roble 300 Ø40 1/2 oak handle 300 Ø40	98,17 €	92,68 €
 T4770	Juego tirador cerezo 200 Ø40 Cherry handle set 200 Ø40	115,42 €	113,37 €
 T4770	Juego tirador cerezo 250 Ø40 Cherry handle set 250 Ø40	125,23 €	117,36 €
 T4770	Juego tirador cerezo 300 Ø40 Cherry handle set 300 Ø40	126,31 €	122,04 €
 T4770S	1/2 tirador cerezo 200 Ø40 1/2 cherry handle 200 Ø40	91,41 €	89,93 €
 T4770S	1/2 tirador cerezo 250 Ø40 1/2 cherry handle 250 Ø40	96,35 €	93,99 €
 T4770S	1/2 tirador cerezo 300 Ø40 1/2 cherry handle 300 Ø40	97,17 €	95,21 €
 ST30 CIRCUM	Soporte para 1/2 tirador Ø30 rosca M8 Support for 1/2 handle Ø30 M8 thread	15,53 €	13,22 €
 ST40 CIRCUM	Soporte para 1/2 tirador Ø40 Support for 1/2 handle Ø40	15,53 €	13,22 €
 STP30 CIRCUM	Soporte para pegar 1/2 tirador Ø30 Support with self adhesive fixing for 1/2 handle Ø30	15,82 €	13,22 €
 STP40 CIRCUM	Soporte para pegar 1/2 tirador Ø40 Support with self adhesive fixing for 1/2 handle Ø40	15,82 €	13,22 €

CIRCUM T2017

Acero Inoxidable AISI 304
AISI 304 Stainless Steel

Acero Inoxidable AISI 316L
AISI 316L Stainless Steel

Ref.	Descripción / Description	IB	IS	IB	IS
 T2017	Juego tirador Ø15 130/170mm Handle set Ø15 130/170mm	68,31 €	60,04 €	77,58 €	68,05 €
 T2017S	1/2 tirador Ø15 130/170mm 1/2 Handle Ø15 130/170mm	57,28 €	52,94 €	63,77 €	58,94 €

CUBITUS

TIRADORES
HANDLES



















Ref.	Descripción / Description	IB	IS	CB	BL/NE
T4757	Juego tirador 200 Ø30 Handle set 200 Ø30	■	■	104,30 €	149,14 €
T4757	Juego tirador 250 Ø30 Handle set 250 Ø30	■	■	106,40 €	151,23 €
T4757	Juego tirador 300 Ø30 Handle set 300 Ø30	■	■	110,29 €	155,18 €
T4757S	1/2 tirador 200 Ø30 1/2 handle 200 Ø30	■	■	89,24 €	116,54 €
T4757S	1/2 tirador 250 Ø30 1/2 handle 250 Ø30	■	■	92,32 €	119,62 €
T4757S	1/2 tirador 300 Ø30 1/2 handle 300 Ø30	■	■	94,69 €	122,07 €
T4757A	Agarradera 200 Ø30 Handle 200 Ø30	■	■	61,96 €	89,38 €
T4757A	Agarradera 250 Ø30 Handle 250 Ø30	■	■	67,50 €	95,50 €
T4757A	Agarradera 300 Ø30 Handle 300 Ø30	■	■	69,46 €	98,30 €
T4757M	Juego tirador METACRILATO 200 Ø30 Methacrylate handle set 200 Ø30	■	■	126,71 €	164,13 €
T4757M	Juego tirador METACRILATO 250 Ø30 Methacrylate handle set 250 Ø30	■	■	134,20 €	171,61 €
T4757M	Juego tirador METACRILATO 300 Ø30 Methacrylate handle set 300 Ø30	■	■	143,14 €	180,55 €
T4757MS	1/2 tirador METACRILATO 200 Ø30 1/2 methacrylate handle 200 Ø30	■	■	89,24 €	107,99 €
T4757MS	1/2 tirador METACRILATO 250 Ø30 1/2 methacrylate handle 250 Ø30	■	■	92,32 €	110,70 €
T4757MS	1/2 tirador METACRILATO 300 Ø30 1/2 methacrylate handle 300 Ø30	■	■	94,69 €	113,80 €
T4790	Juego tirador 300-400 Ø30 Handle set 300-400 Ø30	■	■	157,22 €	117,90 €
T19T	Tirador toallero 520x150x19 mm Towel rail handle 520x150x19m	35,90 €	34,75 €	■	104,30 €
ST30 CUBITUS	Soporte para 1/2 tirador Ø30 rosca M8 Support for 1/2 handle Ø30 M8 thread	12,62 €	11,76 €	18,77 €	23,18 €
STP30 CUBITUS	Soporte para pegar 1/2 tirador Ø30 en vidrio Support with self adhesive fixing Ø30	12,77 €	10,37 €	■	■
10TM	Tornillo manillón Support for handle	■	■	23,99 €	56,89 €



NORMA

TIRADORES
HANDLES

Ref.	Descripción / Description	IB	IS	BL/NE
T4762	Juego tirador 200 ∅20mm Handle set 200 ∅20mm	62,75 €	54,47 €	66,70 €
T4762	Juego tirador 250∅20 mm Handle set 250 ∅20mm	65,06 €	57,01 €	69,25 €
T4762	Juego tirador 300∅20mm Handle 300 ∅20mm	67,85 €	59,25 €	71,80 €
T4762S	1/2 Tirador con soporte 200∅20mm 1/2 handle 200 ∅20mm			
T4762S	1/2 Tirador con soporte 250∅20mm 1/2 handle 250 ∅20mm	CONSULTAR		
T4762S	1/2 Tirador con soporte 300∅20mm 1/2 handle 300 ∅20mm			
T4764	Juego tirador 200 ∅20mm Handle set 200 ∅20mm	65,14 €	62,11 €	66,70 €
T4764	Juego tirador 250∅20 mm Handle set 250 ∅20mm	69,12 €	67,85 €	73,07 €
T4764	Juego tirador 300∅20mm Handle set 300 ∅20mm	71,42 €	70,40 €	75,37 €
T4764S	1/2 Tirador con soporte 200 ∅20mm 1/2 handle 200 ∅20mm			
T4764S	1/2 Tirador con soporte 250 ∅20mm 1/2 handle 250 ∅20mm	CONSULTAR		
T4764S	1/2 Tirador con soporte 300 ∅20mm 1/2 handle 300 ∅20mm			
T4766	Juego tirador regulable ∅30 Adjustable handle set ∅30	259,30 €	226,23 €	■
T4768	Juego tirador regulable ∅20 Adjustable handle set ∅20	246,06 €	215,28 €	■
T4766S	1/2 tirador regulable ∅30 1/2 adjustable handle ∅30	140,49 €	123,83 €	■
T4768S	1/2 tirador regulable ∅20 1/2 adjustable handle ∅20	135,20 €	119,25 €	■
T4780	Tirador toallero ∅20 con pomo tirador ∅20 500x520mm Towel rail handle ∅20 with knob 500x520mm	50,99 €	49,85 €	55,11 €

36 POMOS / KNOBS

Ref.	Descripción / Description	CB	NQS	IB	IS	BL/NE
 GREGAL35	Juego pomos fijos Ø35 Set of fix knobs Ø35	22,76 €	37,88 €	50,28 €	50,28 €	33,01 €
 GREGAL35S	1/2 pomo fijo Ø35 1/2 fix knob Ø35	22,44 €	26,82 €	48,20 €	48,20 €	32,55 €
 LLEVANT50	Juego pomos fijos Ø50 Set of fix knobs Ø50	■	■	57,50 €	57,50 €	83,38 €
 LLEVANT50S	1/2 pomo fijo Ø50 1/2 fix knob Ø50	■	■	39,35 €	39,35 €	57,04 €
 MESTRAL60	Juego pomos fijos Ø60 Set of fix knobs Ø60	65,33 €	71,60 €	66,30 €	68,45 €	94,73 €
 MESTRAL50	Juego pomos fijos Ø50 Set of fix knobs Ø50	59,37 €	64,65 €	63,99 €	66,92 €	86,09 €
 MESTRAL35	Juego pomos fijos Ø35 Set of fix knobs Ø35	36,74 €	49,98 €	■	■	53,27 €
 MESTRAL60S	1/2 pomo fijo Ø60 1/2 fix knob Ø60	44,19 €	50,52 €	46,34 €	45,53 €	64,07 €
 MESTRAL50S	1/2 pomo fijo Ø50 1/2 fix knob Ø50	42,68 €	47,43 €	42,38 €	42,33 €	61,88 €
 MESTRAL35S	1/2 pomo fijo Ø35 1/2 fix knob Ø35	30,35 €	37,33 €	■	■	44,00 €
 PONENT35	Juego pomos fijos Ø35 Set of fix knobs Ø35	23,53 €	24,89 €	■	■	34,11 €
 PC50	Dedal corredera para pegar Ø50 Sliding handle with adhesive Ø50	■	■	18,03 €	18,03 €	■
 PC60	Dedal corredera para pegar Ø60 Sliding handle with adhesive Ø60	■	■	23,32 €	23,32 €	■
 PCC50	Dedal ciego corredera Ø50 Blind handle Ø50	31,11 €	48,25 €	■	■	45,11 €
 PCP50	Dedal pasante corredera Ø50 Through handle Ø50	31,77 €	53,33 €	■	■	46,07 €
 SP35	Soporte 1/2 pomo Ø30 rosca M8/M10 Support 1/2 knob Ø30 M8/M10 thread	10,71 €	11,43 €	8,28 €	7,69 €	15,53 €
 SP50	Soporte 1/2 pomo Ø50 rosca M10 Support 1/2 knob Ø50 M10 thread	12,37 €	14,26 €	9,78 €	8,07 €	17,93 €
 SP60	Soporte 1/2 pomo Ø60 rosca M12 Support 1/2 knob Ø60 M12 thread	13,09 €	14,90 €	16,88 €	17,82 €	18,99 €
 CT	Cubre taladros Ø35 Cover drills Ø35	25,93 €	28,80 €	■	■	37,60 €

Ref.	Descripción / Description	AN-BR	AN PM	AN IS	AN NE
 MIGJORN	Juego pomos fijos ø50 Set of fix knobs ø50	66,82 €	63,73 €	69,18 €	96,89 €
 TRAMUNTANA	Juego pomos fijos ø50 Set of fix knobs ø50	68,08 €	59,58 €	64,98 €	98,71 €

37 MARQUESINAS / CANOPY SYSTEM

COPERTA

MARQUESINAS
CANOPIES

Ref.	Descripción / Description	IB
9500M	Simple para voladizo de 800 a 1200mm placas anclaje pared redondas <i>Simple for glass from 800 to 1200mm, round fastening plate glass/wall</i>	411,27 €
9501M	Simple para voladizo de 1300 a 1700mm placas anclaje pared redondas <i>Simple for glass from 1300 to 1700mm, round fastening plate glass/wall</i>	449,20 €
9510M	Doble para voladizo de 800 a 1200mm placas anclaje pared redondas <i>Double for glass from 800 to 1200mm, round fastening plate glass/wall</i>	490,28 €
9511M	Doble para voladizo de 1300 a 1700mm placas anclaje pared redondas <i>Double for glass from 1300 to 1700mm, round fastening plate glass/wall</i>	537,47 €
9520M	Simple para voladizo de 800 a 1200mm placas anclaje pared rectangulares <i>Simple for glass from 800 to 1200mm, rectangular fastening plate glass/wall</i>	367,40 €
9521M	Simple para voladizo de 1300 a 1700mm placas anclaje pared rectangulares <i>Simple for glass from 1300 to 1700mm, rectangular fastening plate glass/wall</i>	409,08 €
9522M	Doble para voladizo de 800 a 1200mm placas anclaje pared rectangulares <i>Double for glass from 800 to 1200mm, rectangular fastening plate glass/wall</i>	464,03 €
9523M	Doble para voladizo de 1300 a 1700mm placas anclaje pared rectangulares <i>Double for glass from 1300 to 1700mm, rectangular fastening plate glass/wall</i>	504,48 €

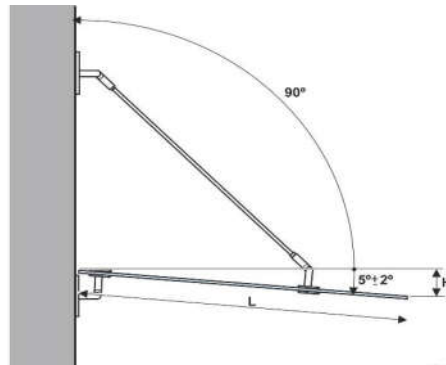

Inclinaciones aproximadas de la marquesina según voladizo, calculado con las roscas del tirante en su punto mínimo/máximo
Approximate inclinations of the canopy system according the fastening plate; it's calculated with the thread of the connecting rod in his minimum/ maximum point.

L (mm)	H (mm)
800	42 a 97
1200	63 a 146
1300	68 a 158
1700	89 a 207

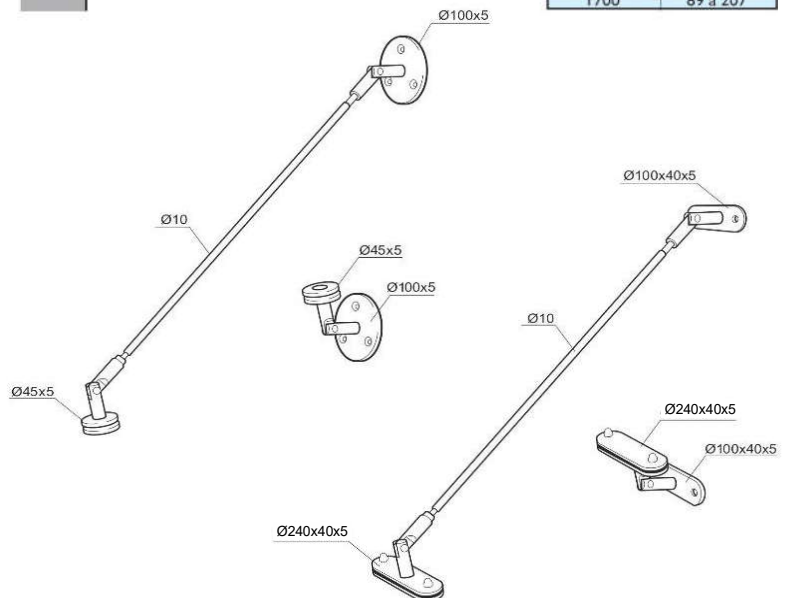







38

RECAMBIOS Y ACCESORIOS
SPARE PARTS & ACCESSORIES



POMOS

KNOBS

Ref.	Descripción / Description	CB	NQS	IB	IS
 001R	Juego pomos cerradura (AIS1316L GRC5) <i>Knobs for lock (AIS1316L GRC5) set</i>	■	■	53,92 €	74,00 €
 002R	1/2 pomo fijo cerradura (AIS1316L GRC5) <i>1/2 fix knob for lock (AIS1316L GRC5)</i>	■	■	28,98 €	39,00 €
 003R	1/2 pomo móvil cerradura (AIS1316L GRC5) <i>1/2 knob for lock (AIS1316L GRC5)</i>	■	■	28,98 €	38,99 €
 014R	Juego pomos cerradura (LATÓN GRC5) <i>Knobs for lock (Brass GRC5) set</i>	55,67 €	75,76 €	■	■
 015R	1/2 pomo fijo cerradura (LATÓN GRC5) <i>1/2 fix knob for lock (Brass GRC5)</i>	29,46 €	39,49 €	■	■
 016R	1/2 pomo móvil cerradura (LATÓN GRC5) <i>1/2 knob for lock (Brass GRC5)</i>	31,43 €	41,48 €	■	■

MANILLAS (AIS1316L GRC5)

HANDLES (AIS1316L GRC5)

Ref.	Descripción / Description	IB	IS
 004R	Juego manillas cerradura <i>Handles for lock set</i>	54,95 €	75,65 €
 006R	1/2 manillas móvil cerradura <i>1/2 handle for lock</i>	28,44 €	38,80 €



CILINDROS

CYLINDERS

Ref.	Descripción / Description	NQS
 007R	1/2 Cilindro euro perfil (32-10) - Leva 15 <i>1/2 cylinder euro perfil (32-10) - Draft 15</i>	49,20 €
 008R	Cilindro euro perfil (32-32) condensado - Leva 15 <i>Cylinder Europerfil function with WC thumbturn (32-32) - Draft 15</i>	61,01 €
 009R	Cilindro euro perfil (32-32) - Leva 15 <i>Cylinder Europerfil (32-32) - Draft 15</i>	56,84 €
 029R	Cilindro euro perfil (32-50) - Leva 15 <i>Cylinder Europerfil (32-50) - Draft 15</i>	64,06 €
 039RP	Cilindro euro perfil para plinto (32-32) - Leva 13,25 <i>Cylinder Europerfil (32-50) door rails - Draft 13,25</i>	59,60 €

CERRADEROS ELECTRÓNICOS

ELECTRONIC STRIKE BOXES

Ref.	Descripción / Description	
 213C	Emisor telemando INALTRONIC <i>Issuing remote control</i>	94,46 €
 215C	Módulo interfono INALTRONIC <i>Interphone Module</i>	98,86 €

TAPAS EMBELLECEDORAS

COVER PLATES

Ref.	Descripción / Description	IB	IS	NE
ESPLUGUES				
CP58	Tapa ESPLUGUES <i>ESPLUGUES cover plate</i>	9,18 €	■	36,77 €
CP47/1	Caja ESPLUGUES <i>Box for ESPLUGUES spring floor</i>	■	■	23,05 €
G75				
CPG75	Tapa G75 <i>G75 cover plate</i>	8,49 €	8,49 €	29,32 €
G75C200	Tapa G75C200 <i>G75C200 cover plate</i>	11,70 €	11,70 €	29,32 €
G75ST	Conjunto caja y tapa suelo técnico <i>Box and cover plate set for technic floor</i>	74,50 €	74,50 €	■
G100A-G100EA				
CPG100A	Conjunto tapas G100A <i>Cover plate set for G100A</i>	22,14 €	19,59 €	■
CPG100EA	Conjunto tapas G100EA <i>Cover plate set for G100EA</i>	27,55 €	24,46 €	■
CPG100TS	Conjunto tapas base suelo G100A / G100EA <i>Set of floor base covers for G100A / G100EA</i>	14,17 €	13,35 €	■
BISAGRAS DECO				
DECO T	Tapa embellecedora <i>Trim cover</i>	10,61 €	10,61 €	10,61 €
DECO TBPC	Tapa embellecedora base pared centrada <i>Wall base trim cover</i>	8,10 €	8,10 €	8,10 €
DECO TBPE	Tapa embellecedora base pared esquina <i>Corner well base trim cover</i>	8,10 €	8,10 €	8,10 €

39**ARTÍCULOS DE REPOSICIÓN / REPLACEMENT ARTICLES****HERRAJES**















FITTINGS



Ref.	Descripción / Description	CB	NQS	IB	IS
1M - 2M 3M - 10M	Cierrapuertas ESPLUGUES estándar leva moderna <i>Standard floor spring ESPLUGUES special pivot</i>	■	■	203,14 €	■
A50	Pernio alto <i>Top patch</i>	■	■	42,94 €	32,63 €
B501	Pernio bajo leva moderna <i>Bottom patch</i>	■	■	65,27 €	55,72 €
G501	Punto de giro montante aleta <i>Overpanel patch with fixing plate</i>	■	■	56,54 €	52,53 €
G502	Punto de giro montante desplazable <i>Overpanel patch with fixing plate and moveable</i>	■	■	54,52 €	41,86 €

HERRAJES

FITTINGS

Ref.	Descripción / Description	CB	NQS	IB	IS
 G50L	Punto de giro lateral montante <i>Overpanel and side panel patch</i>	■	■	94,94 €	77,29 €
 RCG	Punto de giro superior para A50 <i>Top patch for A50</i>	■	■	13,58 €	12,38 €
 S2L	Unión dos lunas <i>Connector glass/glass</i>	■	■	35,40 €	25,07 €
 S2LPC	Unión puerta corredera <i>Connector for sliding glass door</i>	■	■	45,90 €	35,59 €
 S3L	Unión tres lunas <i>Connector for glasses</i>	■	■	45,33 €	35,69 €
 S3LC	Unión tres lunas taladros ciegos <i>Connector for glasses with blind drills</i>	■	■	40,81 €	32,84 €
 S3LT	Unión tres lunas tope <i>Connector for glasses with stopper</i>	■	■	50,86 €	39,64 €
 S3LT90°	Unión tres lunas tope ángulo 90º <i>Connector for glasses with stopper angle 90º</i>	■	■	52,29 €	51,63 €
 S3LTC	Unión tres lunas tope taladros ciegos <i>Connector for glasses with stopper with blind drills</i>	■	■	44,92 €	36,86 €
 TM	Tejuelo M para pernio bajo B501 <i>Bottom M pivot pin for B501</i>	■	■	27,59 €	27,59 €
 330M	Punto de giro techillo para 323M <i>Top pivot pin for 323M</i>	■	■	19,15 €	19,15 €
 ALP	Apoyo lateral puerta <i>Support side door</i>	■	■	33,83 €	43,63 €
 451N/RCGT	Punto de giro superior techillo Ø32mm <i>Top pivot pin Ø32mm</i>	■	■	19,75 €	17,87 €
 S1LBD	Unión una luna vértices <i>Connector vertex</i>	■	■	34,90 €	30,55 €





HERRAJES PARA GRANDES DIMENSIONES

FITTINGS FOR BIG DIMENSIONS

Ref.	Descripción / Description	IB	IS	BL/NE
	Pernio alto para vidrio de 10/11/12mm <i>Top patch for glass thickness 10/11/12mm</i>	164,82 €	145,84 €	242,28 €
	Pernio alto para vidrio de 13/14/15mm <i>Top patch for glass thickness 13/14/15mm</i>	173,75 €	155,42 €	255,41 €
	Pernio alto para vidrio de 16/17/18mm <i>Top patch for glass thickness 16/17/18mm</i>	173,75 €	155,42 €	255,41 €
	Pernio alto para vidrio de 19/20/22mm <i>Top patch for glass thickness 19/20/22mm</i>	175,98 €	157,66 €	258,68 €

HERRAJES PARA GRANDES DIMENSIONES

FITTINGS FOR BIG DIMENSIONS

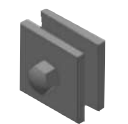
Ref.	Descripción / Description	IB	IS	BL/NE
	9002 Pernio bajo regleta para vidrio de 10/11mm <i>Bottom patch for glass thickness 10/11mm</i>	152,20 €	139,52 €	223,75 €
	Pernio bajo regleta para vidrio de 12/13mm <i>Bottom patch for glass thickness 12/13mm</i>	167,79 €	149,08 €	246,65 €
	Pernio bajo regleta para vidrio de 14/15/16mm <i>Bottom patch for glass thickness 14/15/16mm</i>	167,79 €	149,08 €	246,65 €
	Pernio bajo regleta para vidrio de 18/19/20mm <i>Bottom patch for glass thickness 18/19/20mm</i>	170,01 €	151,31 €	249,90 €
	Pernio bajo regleta para vidrio de 22mm <i>Bottom patch for glass thickness 22mm</i>	170,01 €	151,31 €	249,90 €
	9003 Punto de giro montante para vidrio de 10/11/12mm <i>Overpanel patch glass thickness 10/11/12mm</i>	165,04 €	153,53 €	242,61 €
	Punto de giro montante para vidrio de 13/14/15mm <i>Overpanel patch for glass thickness 13/14/15mm</i>	180,63 €	157,10 €	265,53 €
	Punto de giro montante para vidrio de 16/17/18mm <i>Overpanel patch for glass thickness 16/17/18mm</i>	180,65 €	157,10 €	265,55 €
	Punto de giro montante para vidrio de 19/20/22mm <i>Overpanel patch for glass thickness 19/20/22mm</i>	182,88 €	159,31 €	268,84 €
	9004 Punto de giro lateral montante para V. 10/11/12mm <i>Overpanel & side panel patch for 10/11/12mm</i>	231,95 €	208,50 €	340,96 €
	Punto de giro lateral montante para V. 13/14/15mm <i>Overpanel & side panel patch for 13/14/15mm</i>	253,48 €	220,05 €	372,61 €
	Punto de giro lateral montante para V. 16/17/18mm <i>Overpanel & side panel patch for 16/17/18mm</i>	253,48 €	220,05 €	372,61 €
	Punto de giro lateral montante para V. 19/20/22mm <i>Overpanel & side panel patch for 19/20/22mm</i>	255,69 €	222,28 €	375,86 €
	9005 Unión tres lunas para vidrio de 10/11/12/13mm <i>Connector for glass thickness 10/11/12/13mm</i>	148,35 €	132,11 €	218,08 €
	Unión tres lunas para vidrio de 14/15/16mm <i>Connector for glass thickness 14/15/16mm</i>	163,98 €	141,69 €	241,05 €
	Unión tres lunas para vidrio de 18/19/20/22mm <i>Connector for glass thickness 18/19/20/22mm</i>	166,19 €	143,91 €	244,30 €
	9006 Pernio bajo Cuadradillo 16/19 para vidrio de 10/11mm <i>Bottom patch square pivot 16/19 for glass thickness 10/11mm</i>	215,82 €	196,81 €	317,26 €
	Pernio bajo Cuadradillo 16/19 para vidrio de 12/13/14mm <i>Bottom patch square pivot 16/19 for glass 12/13/14mm</i>	231,39 €	206,41 €	340,14 €
	Pernio bajo Cuadradillo 16/19 para vidrio de 15/16/17mm <i>Bottom patch square pivot 16/19 for glass thickness 15/16/17mm</i>	231,39 €	206,41 €	340,14 €
	Pernio bajo Cuadradillo 16/19 para vidrio de 18/19/20/22mm <i>Bottom patch square pivot 16/19 for glass thickness 18/19/20/22mm</i>	233,87 €	208,83 €	343,79 €
	9007 Unión una luna para vidrio de 10/11/12/13mm <i>Connector for glass thickness 10/11/12/13mm</i>	83,67 €	68,03 €	123,00 €
	Unión una luna para vidrio de 14/15/16mm <i>Connector for glass thickness 14/15/16mm</i>	98,74 €	83,67 €	145,15 €
	Unión una luna para vidrio de 18/19/20/22mm <i>Connector for glass thickness 18/19/20/22mm</i>	102,50 €	87,43 €	150,68 €

HIDROBI**BISAGRAS HIDRÁULICAS . Vidrio 8/10/12mm**
HYDRAULIC HINGES . 8/10/12mm glass

Ref.	Descripción/Description	AN-OBR	AN BR	AN IS	AN PM	AN/NE
H1101	Base fijación centrada (Biselada) <i>Base with centered fastening (Bevelled)</i>	■	■	244,74 €	244,74 €	257,55 €
H1102	Base fijación desplazada (Biselada) <i>Base with displaced fastening (Bevelled)</i>	■	■	244,74 €	244,74 €	257,55 €
H1103	Doble mismo plano (Biselada) <i>Double glass/glass 180° (Bevelled)</i>	■	■	307,80 €	307,80 €	327,60 €

HIDROBI A-MARK III**BISAGRAS HIDRÁULICAS ALINEABLES (GRC5-UNE EN 1670:2007/AC:2008)**
V8/10/12mm
HYDRAULIC HINGES (GRC5-UNE EN 1670:2007/AC:2008) V8/10/12mm

Ref.	Descripción/Description	AN-OBR	AN BR	AN IS	AN PM	AN/NE
H2201A	Base fijación centrada Mark III GRC 5 <i>Base with centered fastening Mark III GRC 5</i>	271,83 €	266,51 €	254,37 €	254,37 €	254,37 €
H2202A	Base fijación desplazada Mark III GRC 5 <i>Base with displaced fastening Mark III GRC 5</i>	271,83 €	266,51 €	254,37 €	254,37 €	254,37 €
H2203A	Doble mismo plano Mark III GRC 5 <i>Double glass/glass 180° Mark III GRC 5</i>	346,17 €	335,53 €	323,31 €	323,31 €	323,31 €

HIDROBI A-M MARK III**BISAGRAS ALINEABLES CON RETENCION MECANICA**
(GRC5-UNE EN 670:2007/AC:2008) V8/10/12mm*HINGES WITH MECHANICAL RETENTION (GRC5-UNE EN 1670:2007/AC:2008) V8/10/12mm*

Ref.	Descripción/Description	AN-OBR	AN BR	AN IS	AN PM	AN/NE
H2204A	Base fijación centrada <i>Base with centered fastening</i>	236,66 €	231,35 €	219,18 €	219,18 €	219,18 €
H2205A	Base fijación desplazada <i>Base with displaced fastening</i>	236,66 €	231,35 €	219,18 €	219,18 €	219,18 €
H2206A	Doble mismo plano <i>Double glass/glass 180°</i>	288,89 €	278,24 €	266,03 €	266,03 €	266,03 €

40 GLOSARIO DE ABREVIACIONES / GLOSSARY OF ABBREVIATIONS

CB	Cromo brillo - <i>Bright chrome</i>
CM-NE	Cromo mate negro - <i>Black matt chrome</i>
IB	Inox brillo - <i>Bright stainless steel</i>
IS	Inox satinado - <i>Satin stainless steel</i>
NQS	Níquel satinado - <i>Satin nickel</i>
AN-PM	Anodizado plata mate - <i>Matt silver anodised</i>
AN-IS	Anodizado inox satinado - <i>Stainless-steel anodised</i>
AN-BR	Anodizado brillo - <i>Bright anodized</i>
AN-OBR	Anodizado oro brillo - <i>Bright gold anodised</i>
AN-NE	Anodizado negro - <i>Black anodized</i> -
GRC 5	Grado de corrosión 5 / <i>Corrosion degree 5</i>
(/T)	Tope para cerradura V10/12mm en mecanismo, con apertura hacia el exterior, para instalación con cerradero SIN eléctrico <i>Stop for 10/12mm lock in mechanism, with outwards opening and installation with non-electric strike box</i>
(/TE)	Tope para cerradura V10/12mm en mecanismo, con apertura hacia el exterior, para instalación con cerradero eléctrico <i>Stop for 10/12mm lock in mechanism, with outwards opening and installation withn electric strike box</i>
(/SCU)	Tope V10/12mm en la escuadra para cerradura con apertura hacia el exterior <i>Stop for 10/12mm glass in the square for outwards opening lock</i>
Pi	Picaporte / <i>Latch</i>
Pa	Palanca / <i>Lever</i>

41 CONDICIONES GENERALES DE VENTA

1. Generalidades

El pedido hecho por el cliente constituye una oferta vinculante que deberá ser aceptada expresamente por Industrias Galtés, S.A., mediante el envío de los productos solicitados, quedando vinculadas, a partir de este momento, ambas partes, en base a las presentes condiciones generales de venta. Todos los pedidos y suministros a efectuar por Industrias Galtés, S.A., se regirán por las presentes Condiciones Generales de Venta. Únicamente tendrán validez otras condiciones generales si están reconocidas por Industrias Galtés, S.A., en adelante IG, por escrito. Por ello, carecen de valor a todos los efectos, cualesquiera otras condiciones que no se hayan pactado expresamente con IG.

2. Formalización de pedidos y alcance del suministro

El alcance del suministro deberá estar claramente especificado en el pedido del comprador, indicando la referencia del producto de IG, así como su acabado. Todos los pedidos se cursarán por escrito o correo electrónico. Las modificaciones y/o el alcance de un pedido que pueda proponer una de las partes, deberá notificarse a la otra parte, siempre por escrito y para que sean válidas, deberán ser aceptadas expresamente por ambas.

3. Planos y Documentación técnica

Nuestros prospectos y catálogos, independientemente del medio en que vengán publicados, no representan una obligación de compromiso por parte de IG, especialmente si las características descritas no están reconocidas y garantizadas expresamente por escrito. Ambas partes se reservan sus derechos sobre planos, dibujos y otra documentación técnica que hayan entregado al comprador, esta entrega no afecta a los Derechos de Propiedad Intelectual e Industrial de IG, que permanecen plenamente vigentes. La parte receptora reconoce estos derechos y se compromete a no entregar sin autorización escrita de la otra parte esta documentación a terceros, ni parcialmente ni en su totalidad, para fines no acordados previamente.

4. Precios

Todos los precios se entenderán como precios sin descuentos ni impuestos. El importe del Impuesto sobre Valor Añadido y/o demás impuestos que sean aplicables, se repercutirán posteriormente en la factura con los tipos correspondientes. En el caso de ofertas previas al pedido, los precios ofertados tienen validez de un mes, siendo únicamente válidos para la totalidad de los productos especificados en dicha oferta.

5. Plazo de entrega

El plazo de entrega queda confirmado cuando se cierra el acuerdo y éste cumpla todos los requisitos legales.

El plazo de entrega será modificado cuando:

- IG no reciba la documentación necesaria, o el cliente solicite modificaciones y provoque un retraso en el suministro.
- Por causas no directamente imputables a IG, se produzcan retrasos en la producción o se reciban materiales por parte de los proveedores de IG con retraso y/u ocasionen fabricaciones con defectos de calidad.
- Por razones de fuerza mayor.

6. Transportes

Salvo acuerdo previo con el comprador, el transporte, incluyendo las cargas y descargas, se realizará bajo riesgo de éste, por lo que IG es ajeno a cualquier reclamación respecto a daño o menoscabo del suministro, siendo por cuenta del comprador la asunción de dichos riesgos.

En los envíos a la Península e Islas Baleares por importe superior a 600€, los portes serán a cuenta de IG, enviando el transporte por el medio habitual.

El importe mínimo para los envíos a portes pagados al archipiélago canario será de 1.800€, y a Portugal de 900€.

Cuando por petición expresa del cliente el envío deba efectuarse por otros medios o por transporte urgente, los portes serán a cargo de éste. No se admitirán reclamaciones transcurridos 10 días desde la emisión del albarán. Según Real Decreto 782/98 de 30 de abril, Artículo 18 y Ley 11/1997, de 24 de abril, sobre Envases y Residuos de Envases, como receptor final de nuestro embalaje, es responsabilidad del comprador dar el tratamiento medioambiental más adecuado al mismo.

7. Reclamaciones y Devoluciones

Se deberán presentar las reclamaciones indicando la fecha y el número de referencia de la entrega. Únicamente se atenderán las reclamaciones relativas a pedidos solicitados por escrito, aceptando solamente devoluciones de género por motivos imputables a IG. Las condiciones serán las siguientes:

- * Que dichas piezas sean estándares, no se aceptará devolución alguna de piezas especiales.
- * Que la devolución sea previamente notificada y expresamente aceptada por IG.
- * Que no hayan transcurrido 30 días desde la entrega de la mercancía.

El cliente deberá notificar en un plazo máximo de 30 días por escrito a Industrias Galtés, S.A., posibles deficiencias en los productos adquiridos, en caso contrario el cliente habrá aceptado el suministro. Una vez recepcionada la notificación del cliente, indicando el motivo de la incidencia, número de referencia, número de albarán y fecha de entrega, IG, informará al cliente en un plazo máximo de 15 días del resultado del informe de la No Conformidad abierta, según protocolo interno de conformidad y aceptación. Si esta reclamación es aceptada por IG, se formalizará y comunicará al cliente para que éste realice el envío y haga visible en la mercancía la referencia de la NC en cuestión. Las devoluciones de material, ya sea para su abono, sustitución o reparación, deberán hacerse siempre a Portes Pagados. Una vez verificada la mercancía, si procede, se efectuará el abono que corresponda en cada caso según tarifa de portes de IG. Las reparaciones, modificaciones o acabados deberán efectuarse por IG y en ningún caso el cliente podrá pretender cargos por las asumidas o encargadas a terceros. IG no admitirá devoluciones de productos diseñados o fabricados específicamente para el pedido.

IG se reserva el derecho a rechazar devoluciones que contengan mercancía en mal estado. El abono de cualquier material cuya naturaleza proceda de una devolución en la que IG no sea responsable, no superará el 90% del valor facturado. Se abonará al cliente el valor de la venta en su día, menos los gastos incurridos en recepción y reenvasado (si fuera necesario), puesto en nuestro almacén, así como el transporte del envío inicial.

En las devoluciones cuyo origen no provenga de una No Conformidad, seguiremos las siguientes normas:

1. No se admitirán devoluciones cuyo importe sea superior a 1.000€.
2. Deberá ir acompañada de un albarán de entrega con nuestro nº de pedido, en porte pagado y en el embalaje original.
3. Las devoluciones de material también irán acompañadas de un Formulario de Devolución de Material debidamente cumplimentado. Así que se deberá solicitar una RMA (Autorización de devolución de Material) de las unidades pertinentes. Posteriormente IG estudiará la solicitud y procederá según cada caso.
4. En ningún caso se abonarán piezas y acabados especiales.

8. Tribunal de arbitraje y legislación aplicable

Para cualquier litigio que pudiera derivarse de la relación entre IG, como proveedor y sus clientes, ambas partes se someten expresamente al Fuero de los Juzgados y Tribunales de Barcelona, con renuncia expresa a cualquier otro fuero y domicilio. Este documento es meramente de información comercial, los datos que en él se incluyan (precios, dimensiones, etc.) no tienen carácter contractual.

Industrias Galtés, S.A. Reservado el derecho a modificación. Castellbisbal (Barcelona), Enero 2022 V.2022.1

41 GENERAL CONDITIONS OF SALES

1. General

The order made by the customer is a binding offer which must be accepted expressly by Industrias Galtés, S.A., by means of sending the products ordered and, from now on, both sides shall be bound to these general conditions of sales. All orders and supplies by Industrias Galtés, S.A., are subjected to the present general conditions of sales. Any deviating general business terms will only apply if they are expressly confirmed in writing by Industrias Galtés, S.A., from now on IG. Therefore, other conditions that have not been explicitly by IG shall have no legal value or effect whatsoever.

2. Order formalization and scope of supply

The scope of supply should be clearly specified on the buyer's order, including the reference and finished. All orders must be in writing or e-mail. The changes and/or the scope of orders proposed by one of side, always must be notified to the other side in writing and they must be expressly accepted by both sides.

3. Drawings and Technical Documentation

Whatever the method to publish our conditions and products, it doesn't represent a commitment by IG, especially if the characteristics described are not acknowledged and guaranteed expressly in writing. Both sides reserve their rights about the drawings, graphics and other technical documentation which have been delivered to the buyer. It doesn't affect to the Intellectual Property and Industrial Rights of IG which remain completely valid. The receptor acknowledges these rights and undertakes not to delivery these documents to any third parties, either in part or in full without specific consent in writing by the other part.

4. Prices

The prices include neither discount nor taxes. The Value-Added Tax (VAT) and/or other applicable taxes shall be charged subsequently in the invoice at the respective rates. In the case of offers prior the order, the prices quoted are valid for one month, remaining valid for the total products specified in the offer.

5. Delivery date

The delivery date is confirmed at the time the agreement is negotiated and that it meets all legal requirements.

The delivery date will be modified in case of:

- If IG doesn't receive the needed documentation or the customer requires modifications of the purchase order which could change the delivery date.
- If there are delays in the production, for receiving the products delayed or with quality problems from our supplier, it will not directly attributable to IG.
- For reasons of force majeure.

6. Transport

Except by prior agreement with the customer, the transport, including the loading and unloading, shall be carried out for the account and at the risk of the customer, and IG shall be free from whatsoever claim in respect of the supply's damage, the customer shall be solely responsible for its custody and maintenance.

For shipments to the Iberian Peninsula and to the Balearic Island: The cost of transport will be paid by IG if the total amount is more than 600€, by the usual transport.

For shipments to the Canaries, the cost of transport will be paid by IG if the total amount is more than 1.800€, and to Portugal more than 900€.

When the customer expressly requests the sending by a different means of transport or by Express transport, the costs will be paid by the customer. Claims will not be admitted 10 days after the issuing of the delivery note. According to Royal Decree 782/98 of April 30, under Article 18 and Law 11/1997, of April 24, on packaging and packaging waste, as the final recipient of our packaging, the responsibility of the purchaser is to apply the most appropriate environmental treatment in this one.

7. Claims and Returns

Claims shall be reported including the date and the reference number of the delivery. Only the claims of requested orders in writing will be considered, only accepting returns of material for reasons attributable to IG. The conditions are as follows:

- * Must be standard products, the return of special products will not be accepted.
- * The return must be previously notified by the customer and expressly accepted by IG.
- * The claim or return not take place after 15 days following the delivery date.

The customer should notify possible shortcomings in products purchased at the latest within 15 days following the delivery date in writing to Industrias Galtés, S.A. Otherwise, the customer has accepted the material. Upon receipt the notification from the customer with the reason of the incident, reference number, number of the delivery note and the delivery date, IG will inform to the customer within 15 days following the result of the Non-Conformity report, according our internal protocol of conformity and acceptance. If this claim is accepted by IG, it shall be formalised and informed to the customer, and the customer will send goods making visible the reference of the NC. Returns of material whether for their payment, replacement or repair, should always be made in Freight Prepaid. Once the shipment is verified, in case that it corresponds, it will be according the transport price list of IG. The repair or the replacement shall be made by IG. The customer never can charge extra-costs to IG for its IG reserves the right to reject returns which contain damaged goods. The credit note for some material, which is returned and IG is not responsible, will not exceed 90% of the invoiced value. The customer will receive a credit note for the value of sales that day, but not all expenses incurred in the receipt and repackaged (if it's necessary) placed in our warehouse, as well as cost of transport of the initial sending.

The returns which have not a Non-Conformity Report, we apply the follow rules:

1. IG will not accept any return when the total amount is more than 1.000€.
2. The returns must be accompanied by a delivery note with our number order, in Freight Prepaid and in the original packaging.
3. The returns may be also accompanied for a duly completed Product Returns Form. So, the customer should request a RMA number (Return Materials Authorization) provided of all products to return. Later, IG will check the request and will proceed on a case-by-case.
4. In no case will be paid special products or special finishes.

8. Court of arbitration and applicable law

In the event of any dispute arising from the relationship between IG, as supplier, and their customers, both parties shall be subject expressly to the jurisdiction of the judges and Courts of the City of Barcelona, renouncing their own jurisdiction area, if different. This document is purely commercial information, so, all details included in this document (prices, dimensions, etc.) do not have contractual character.

Industrias Galtés, S.A. Reserved the right to amendment. Castellbisbal (Barcelona), January 2022 V.2022.1

CONDICIONES GENERALES DE GARANTÍA GENERAL CONDITIONS OF GUARANTEE

CONDICIONES GENERALES DE GARANTÍA

Industrias Galtés, S.A. garantiza los productos de su catálogo contra defectos de fabricación durante un período de 2 años a contar desde la fecha de compra. La presente garantía no es aplicable a los productos que presenten modificaciones o manipulaciones efectuadas por personal ajeno a IG, sin el consentimiento expreso por escrito de este último.

Si durante el periodo de la garantía, el producto resulta ser defectuoso debido a un fallo en su fabricación o por incorporar algún material o componente defectuoso, IG se compromete a reparar o reponer el producto. Éste disfrutará del periodo de garantía restante correspondiente al producto original.

La presente garantía no será aplicable en los siguientes casos:

- (a) Daños provocados por mal uso del producto
- (b) Por instalación incorrecta de los mismos
- (c) Daños provocados por accidentes

Para tener derecho a esta garantía, es imprescindible acreditar la fecha de recepción del producto, así como número de albarán de entrega. La decisión de aceptación o denegación de una garantía corresponderá a IG.

GENERAL CONDITIONS OF GUARANTEE

Industrias Galtés, S.A. guarantees all products in the catalogue against manufacturer's defects during a period of two years following the date of purchase. This Warranty doesn't apply to products with any alteration or tampering by non-company personnel IG, without prior express written permission of this later. If during the warranty period the product is defective due a problem in its manufacturing or due any defective component, IG undertakes to repair and replace the product. The customer shall be covered for the remainder of the warranty period which corresponds to the original product.

This guarantee shall not apply in the following cases:

- (a) Damages caused for misuse of the product.
- (b) Incorrect installation of the product.
- (c) Damages caused by accidents.

To be fully entitled to your guarantee is essential to demonstrate the date of receipt of the product, as well as the number of the delivery note. The decision to accept or refuse a warranty shall be made by IG.



www.trivelgaltes.com